

MADE IN
GERMANY

Surgical Draping Systems

Premium quality. Efficiency. Variety.

Product Catalogue

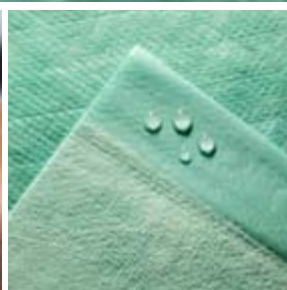

Safety for You and Your Patients

Since 1979, Sengewald, as the only manufacturer for surgical draping systems from the laminating and converting process in Germany, has been developing innovative and user-friendly products. These allow more efficient procedures and make surgeries more prolific and safer. 23 million drapes and 4 million packs speak for themselves – and for us.

In the operating theatre every minute counts. With our Secu-Drape® brand, we offer you a variety of complete draping systems, single drapes in various material qualities, as well as protective clothing to facilitate surgery preparation. With Secu-Tray® you can in addition not only select from existing complete sets, but also compose your own surgical procedure pack – completely according to your own personal needs: As technological market leader, we have the professional competence and flexibility to respond quickly to changing market needs. According to your individual requirements, we combine first-class solutions with high application comfort. You are always welcome to seek advice from our experienced employees. Your need is our challenge, your satisfaction is our goal.

Quality “made in Germany” is our basic attitude which is lived anew every day. Therefore, we focus on the entire production process to ensure compliance and continuous improvement of all product and hygiene standards – for your safety and the protection of your patients.

Last but not least, we care about sustainability. All materials used by Sengewald are 100% free of PVC, emollients and heavy metals.

Universal Drapes

Plain Drapes, Non-Adhesive	12
Aperture Drapes	14
Epidural Drapes, Adhesive	15 – 16
Adhesive Drapes	16 – 18
Split Sheets	19 – 20
Mayo Stand Covers	21
Back Table Covers	21

General Surgery

Universal Packs	24 – 25
MIS Drapes	26
Rectum Drapes/Pack	27
Strumectomy Packs	28
Split Sheet Packs	29

Cardio/Thoracic, Vascular Surgery

Cardio/Thoracic Drapes	32
Bypass Packs	33
Hybrid Drapes	34
Supplementary Products	35
Angiography Drapes	36 – 37

Orthopaedics/Traumatology

Split Sheet Pack	40
Extremity Drapes	41
Extremity Packs	42
Arthroscopy Drapes	43
Arthroscopy Packs	44 – 45

Shoulder Drape	46
Hand Surgery Drapes	47
Hand/Foot Pack/Drapes	48
Hip Pack/Drape	49
Vertical Isolation Drapes	50
Supplementary Products	51 – 53

Urology

Urology Drapes	56 – 57
Urology Packs	58
Split Sheets/DaVinci Drape	59
Small Drapes/Packs	60
Supplementary Products	61

Gynaecology

GYN Drape/Packs	64
Pfannenstiel Drape/Pack	65
C-Section Drapes/Pack	66 – 67
GYN-LAP Drapes	68
Small Drapes	68 – 69

Neurosurgery/ENT/OMS/Eyes

Neurosurgery Drapes	72
Laminectomy Drapes	73
Turban Drape	74
ENT Drapes	74
Eye Drapes	75
Ophthalmological Drapes	76
Supplementary Products	77

Paediatrics

Paediatrics Drapes/Pack	80 – 81
-------------------------	---------

Day Surgery

General Surgery	84 – 85
Traumatology and Orthopaedic Surgery	86 – 88
Gynaecology/Urology	89 – 90
Universal Drapes	91

Supplementary Products

Fluid Collection/Diathermy Pouches	94
Velcro Strip/OR Tape/Incision Film	95
Foot Covers/Stockinettes/Leggings	96
Camera-/Image Intensifier Covers	97
Equipment Covers	98 – 99
Accessory	100 – 101

OR Gowns

OR Gowns Standard/Reinforced	104 – 107
------------------------------	-----------

Protection Products, Unsterile

Scrub Suits/Non-Woven Jackets (Unsterile)	110
Protection/Visitor Gown	111
Disposable Socks	112
Protection Sheets/Aprons/Examination Couch Covers	113

The Premium Quality Material

Mediwell super strong - Symbiosis of comfort and functionality

The basic non-woven

- ✓ Pleasantly soft and extremely absorbent
- ✓ The typical orange skin structure binds fluids of over 6 times own weight

The protective film

- ✓ Perfect barrier against microbes
- ✓ Super soft and absolutely impermeable to fluids
- ✓ The patient remains dry and is safely protected from infections
- ✓ The film is extremely lightweight and nevertheless highly tear resistant

The patient layer

- ✓ The non-woven is especially soft and durable
- ✓ Thanks to the lamination technology with the tiny air cushions it lies even more pleasantly on the skin and provides maximum patient comfort



Custom Procedure Trays (CPT)

Custom-made solutions for your surgical application

Since more than 30 years Secu-Tray® systems from Sengewald combine individuality and standardisation in the OR: 4 million customer-specific packs leave our production facilities per year in more than 2,000 different configurations.

We are happy to support you from the initial consultation up to the adoption of your individual pack in the daily routine in the operating theatre. Alternatively packs can also be selected or modified from our catalogue. Thereby, every component contained in the tray can be tracked back – through this flexibility meets premium quality and absolute material safety.

Our effort – your profit:

- ✓ Competent support in defining the pack contents
- ✓ Indication related and individual composition
- ✓ Process standardisation
- ✓ Increase of efficiency in the OR
- ✓ Absolute cost transparency
- ✓ Less storage space requirement
- ✓ Minimisation of waste



Our products fulfil the highest requirements:

- ✓ High tensile strength
- ✓ High absorption capacity
- ✓ Impervious to bacteria and fluids
- ✓ PP non-woven for maximum patient comfort
- ✓ Latex-free

All multiple and single layer materials are also available in packs that can be completely individually compiled according to your requirements. So you are best prepared for complex interventions. Our products thereby exceed all the requirements of EN 13795 and bear the CE label according to EC directive 94/92 EEC medical devices.

Multiple Layer

Single-Ply

Mediwell

2 or 3-ply material combination; absorbent and impervious to bacteria and fluids, HP.

Uses: as back table covers or a sterile field, patient drapes for minor procedures with low fluid incidence, as a bottom drape.



Mediwell soft

Soft non-woven material, particularly similar to textiles; low-linting, alcohol and fluid-repellent, breathable, very comfortable to wear, SP.

Uses: as a patient drape for ophthalmic surgery, scrub suits, jackets and OR gowns.



Mediwell super

2 or 3-ply material combination; extremely high absorbent capacity, impervious to bacteria and fluids, HP.

Uses: as back table covers, patient drapes for medium to major procedures, as a bottom drape.



Mediwell light

Light SMMMS non-woven; alcohol and fluid-repellent, breathable, comfortable to wear, SP.

Uses: as a patient drape for ophthalmic surgery, OR gowns.



Mediwell super strong

3-ply material combination; extremely high absorbent capacity and highly tear resistant, impervious to bacteria and fluids, HP.

Uses: as patient drapes for medium to major procedures with high fluid incidence.



Filmdrape

Contact transparency, micro-embossed, very drapeable PE film; impervious to bacteria and fluids, HP.

Uses: as a patient drape for minor and medium procedures in anaesthesia and ophthalmology.

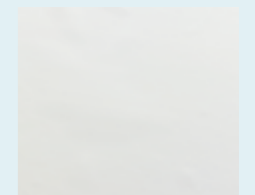

Mediwell absorb

2-ply material combination; as a reinforcement non-woven with high absorptive capacity, very great wet rub-resistance, impervious to bacteria and fluids, HP.

Uses: as a reinforcement for angiography drapes and mayo stand covers as well as for custom drapes for procedures with a very high fluid incidence and/or subject to extremely great demands, also available as freely applicable adhesive drapes.



Colordrape

Very drapeable PE coex film, impervious to bacteria and fluids, turquoise-coloured, HP.

Uses: special applications as patient drapes or as reinforcement in high-performance OR gowns.



aquamarine

2 or 3-ply material combination; very absorbent and exceedingly tear resistant, impervious to bacteria and fluids, HP.

Uses: as back table covers, patient drapes for all procedures.



HP: fulfils the requirements of EN 13795 for High Performance
SP: fulfils the requirements of EN 13795 for Standard Performance

Universal Drapes



Regardless of which intervention you undertake: Our extensive range of universal drapes and back table cover guarantee you maximum flexibility and optimum hygiene. We offer precisely the right solution for every area of application – also custom-made according to your individual requirement.

Our portfolio comprises various models for secure and reliable draping of the patient and the surrounding area in surgical procedures. From standard drapes for day surgeries up to drapes for surgical interventions with large amounts of fluids and highest requirements.



Plain Drapes

Mediwell 2-ply	Qty. dispenser or inliner/PU	Size/cm	Ref. no.
	120 / 720	37,5 x 45	503842
	70 / 420	45 x 75	504572
	45 / 270	75 x 90	507592
	25 / 100	100 x 150	509215
Mediwell 3-ply			
	65 / 390	45 x 75	504575
	35 / 210	75 x 90	507590
	20 / 80	100 x 150	509015
	15 / 60	150 x 180	501518
	10 / 40	150 x 240	501524

Mediwell super 2-ply	Qty. dispenser or inliner/PU	Size/cm	Ref. no.
	60 / 360	45 x 75	508825
	40 / 240	75 x 90	508824
	30 / 180	100 x 100	508858
	20 / 80	100 x 150	508823
	15 / 60	150 x 180	508821
	Pack component	175 x 200	508878-9
	Pack component	200 x 280	508827-9

Mediwell super 3-ply	Qty. dispenser or inliner/PU	Size/cm	Ref. no.
	50 / 300	45 x 75	508805
	30 / 180	75 x 90	508804

Mediwell super strong 3-ply	Qty. dispenser or inliner/PU	Size/cm	Ref. no.
	20 / 80	100 x 150	508803
	11 / 44	150 x 180	508801
	Pack component	150 x 200	508857-9
	10 / 40	150 x 240	508802

aquamarine 3-ply	Qty. dispenser or inliner/PU	Size/cm	Ref. no.
	8 / 32	200 x 200	808879
aquamarine 2-ply			
	27 / 81	100 x 150	808823
	18 / 54	150 x 140	808844
	16 / 48	150 x 180	808821
	14 / 42	150 x 200	808869
	12 / 36	150 x 220	808816
	10 / 30	150 x 250	808819

Filmdrape	Qty. dispenser or inliner/PU	Size/cm	Ref. no.
	Pack component	150 x 200	506620-9

Mediwell soft Baby Sheet	Qty. dispenser or inliner/PU	Size/cm	Ref. no.
	Pack component	90 x 86	585758-9
	30 / 120	100 x 150	585764
	Pack component	120 x 120	585761-9
	Pack component	150 x 130	505712-9

Aperture Drapes

Mediwell 2-ply	Qty. dispenser or inliner/PU	Size/cm	Ref. no.
Aperture Ø 6 cm, central	70 / 420	45 x 75	514572
Aperture Ø 6 cm, central	45 / 270	75 x 90	517592
Mediwell 3-ply			
Aperture Ø 6 cm, central	50 / 300	45 x 75	514575
Aperture Ø 6 cm, central	30 / 180	75 x 90	517590
Mediwell super 2-ply			
Aperture Ø 6 cm, central	70 / 420	45 x 75	518821
Aperture Ø 6 cm, central	45 / 270	75 x 90	518822

Aperture Drapes, Adhesive

Mediwell 2-ply	Qty. dispenser or inliner/PU	Size/cm	Ref. no.
Aperture oval, 5 x 7.5 cm, central	65 / 390	50 x 60	555064
Mediwell super 2-ply			
Aperture Ø 6 cm, central	70 / 420	50 x 60	558823
Aperture Ø 6 cm, central	45 / 270	75 x 75	558971
Aperture oval, 8 x 6 cm, central	40 / 240	75 x 90	558972
Aperture oval, 7 x 10 cm, central	25 / 100	100 x 150	558974
Mediwell super strong 3-ply			
Aperture 15 x 15 cm, central	18 / 72	120 x 150	559075
Filmdrape			
Aperture Ø 6 cm, central	50 / 200	75 x 130	556655

Variable Aperture Drapes, Adhesive, 2-Part

Mediwell super 2-ply	Qty. dispenser or inliner/PU	Size/cm	Ref. no.
Aperture max. 12 x 21 cm	50 / 300	50 x 75	554575
Aperture max. 12 x 21 cm	30 / 180	75 x 90	558948
Aperture max. 18 x 28 cm	30 / 180	75 x 90	558964

Epidural Drapes

Mediwell 2-ply	Qty. dispenser or inliner/PU	Size/cm	Ref. no.
Aperture ◇ 10 x 10 cm, decentral, with adhesive zone 6 x 57 cm	50 / 300	57 x 72	555772
Mediwell super 2-ply			
Aperture Ø 10 cm, decentral, with adhesive zone 6 x 60 cm	Pack component	60 x 75	558838-9
Aperture Ø 10 cm, decentral, adhesive, with adhesive zone 6 x 60 cm	40 / 240	60 x 75	558839
Aperture Ø 10 cm, central, adhesive, with adhesive zone 6 x 75 cm	30 / 180	75 x 75	558989
Aperture oval, 15 x 18 cm, decentral, adhesive, with adhesive zone 5.5 x 75 cm	20 / 80	75 x 100	558991

Mediwell super with transparent film fenestration and perforation	Qty. dispenser or inliner/PU	Size/cm	Ref. no.
Film window 35 x 35 cm, central, 10 cm central adhesive aperture, and adhesive zone 6 x 75 cm	45 / 180	75 x 75	558846
Film window 35 x 35 cm, central, 12 cm central adhesive aperture, and adhesive zone 6 x 75 cm	45 / 180	75 x 75	558848
Film window 35 x 35 cm, central, 10 cm central adhesive aperture, and adhesive zone 6 x 75 cm	35 / 140	75 x 100	558847
Film window 35 x 35 cm, central, 12 cm central adhesive aperture, and adhesive zone 6 x 75 cm	35 / 140	75 x 100	558849

Mediwell super CVC drape	Qty. dispenser or inliner/PU	Size/cm	Ref. no.
Film window 35 x 35 cm, decentral, 9 cm central adhesive aperture	12 / 48	120 x 150	558975

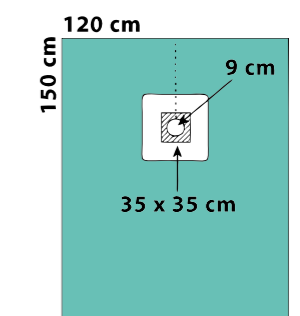
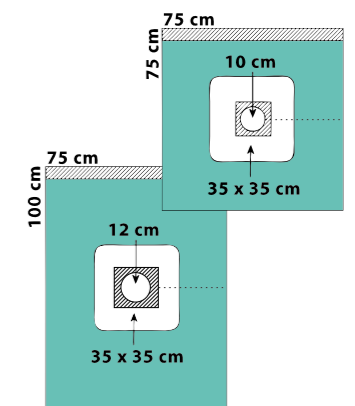
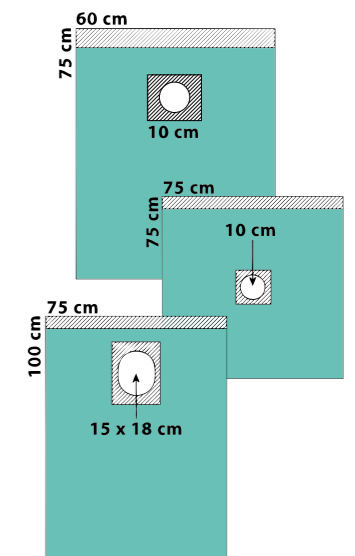
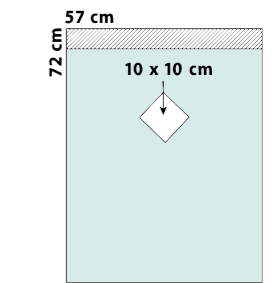

Epidural Drapes

Filmdrape	Qty. dispenser or inliner/PU	Size/cm	Ref. no.
Aperture Ø 10 cm, decentral, adhesive, with adhesive zone 6 x 60 cm	50 / 200	60 x 100	556654

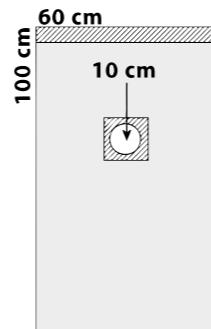

Adhesive Drapes

Mediwell super 2-ply	Qty. dispenser or inliner/PU	Size/cm*	Ref. no.
Adhesive zone 5 x 50 cm	70 / 420	50 x 50	538822
Adhesive zone 5 x 75 cm	65 / 390	50 x 75	538829
Adhesive zone 5 x 75 cm	45 / 270	75 x 75	538821
Adhesive zone 5 x 90 cm	40 / 240	75 x 90	538823
Adhesive zone 5 x 90 cm	Pack component	<u>90</u> x 150	538834-9

Mediwell super 3-ply	Qty. dispenser or inliner/PU	Size/cm*	Ref. no.
Adhesive zone 5 x 50 cm	80 / 480	50 x 50	538802
Adhesive zone 5 x 75 cm	50 / 300	50 x 75	538809
Adhesive zone 5 x 75 cm	35 / 210	75 x 75	538801
Adhesive zone 5 x 90 cm	30 / 180	75 x 90	538803

Mediwell super strong 3-ply	Qty. dispenser or inliner/PU	Size/cm*	Ref. no.
Adhesive zone 5 x 100 cm	30 / 120	75 x 100	538811
Adhesive zone 5 x 100 cm	20 / 80	100 x 100	538813
Adhesive zone 5 x 100 cm	22 / 88	150 x <u>100</u>	538886
Adhesive zone 5 x 80 cm	10 / 40	150 x <u>180</u>	538805
Adhesive zone 5 x 80 cm	10 / 40	150 x <u>240</u>	538807
Adhesive zone 5 x 80 cm	9 / 36	175 x <u>180</u>	538806
Adhesive zone 5 x 240 cm, 3-part 69 / 102 / 69 cm	5 / 20	175 x <u>240</u>	538898
Adhesive zone 5 x 120 cm	5 / 20	175 x <u>300</u>	538808
Adhesive zone 5 x 80 cm	8 / 32	200 x <u>180</u>	538810

* Underlined numbers mark the adhesive side

Adhesive Drapes

Mediwell absorb 2-ply	Qty. dispenser or inliner/PU	Size/cm*	Ref. no.
Adhesive drape absorbent, adhesive zone 5 x 75 cm	30 / 180	50 x 75	538889
Adhesive drape absorbent, adhesive zone 5 x 50 cm	40 / 240	75 x <u>50</u>	538887
Adhesive drape absorbent, adhesive zone 16 x 90 cm	35 / 140	75 x 90	538888

aquamarine 2-ply	Qty. dispenser or inliner/PU	Size/cm*	Ref. no.
Adhesive zone 5 x 100 cm	25 / 150	100 x <u>90</u>	838835

aquamarine 3-ply	Qty. dispenser or inliner/PU	Size/cm*	Ref. no.
Adhesive zone 5 x 80 cm	10 / 30	150 x <u>180</u>	838805
Adhesive zone 5 x 80 cm	8 / 24	150 x <u>240</u>	838807
Adhesive zone 5 x 80 cm	10 / 30	175 x <u>180</u>	838806
Adhesive zone 5 x 120 cm	Pack component	175 x <u>300</u>	838808-9
Adhesive zone 5 x 120 cm	Pack component	250 x <u>300</u>	838960-9

Adhesive Drapes with Special Adhesive for Sensitive Skin

Mediwell super 3-ply	Qty. dispenser or inliner/PU	Size/cm	Ref. no.
Adhesive zone 2.5 x 50 cm	Pack component	75 x <u>50</u>	538912-9

Mediwell super strong 3-ply with 2.5 cm adhesive zone	Qty. dispenser or inliner/PU	Size/cm*	Ref. no.
Adhesive zone 2.5 x 100 cm	40 / 160	75 x <u>100</u>	538914
Adhesive zone 2.5 x 80 cm	Pack component	175 x <u>180</u>	538916-9
Adhesive zone 2.5 x 80 cm	Pack component	150 x <u>240</u>	538917-9

Mediwell super strong 3-ply with 5 cm adhesive zone	Qty. dispenser or inliner/PU	Size/cm*	Ref. no.
Adhesive zone 5 x 100 cm	Pack component	75 x <u>100</u>	538915-9
Adhesive zone 5 x 120 cm	40 / 120	100 x <u>120</u>	538944
Adhesive zone 5 x 80 cm	Pack component	150 x <u>240</u>	538918-9
Adhesive zone 5 x 80 cm	Pack component	175 x <u>180</u>	538943-9
Adhesive zone 5 x 180 cm, 2-part 90 / 90	Pack component	175 x <u>180</u>	538920-9
Adhesive zone 5 x 300 cm, 3-part 90 / 120 / 90	Pack component	175 x <u>300</u>	538942-9

Split Sheets

Mediwell super 2-ply	Qty. dispenser or inliner/PU	Size/cm	Ref. no.
U-slit 7 x 40 cm, adhesive	25 / 150	75 x 90	528855
U-slit 7 x 30 cm, adhesive	30 / 180	90 x 75	528866

Mediwell super strong 3-ply	Qty. dispenser or inliner/PU	Size/cm*	Ref. no.
U-slit 7.5 x 45 cm, adhesive	15 / 60	120 x <u>150</u>	528801
U-slit 7.5 x 65 cm, adhesive	10 / 40	160 x <u>200</u>	528802
U-slit 7.5 x 65 cm, with special adhesive for sensitive skin	7 / 14	<u>200</u> x 260	528815
U-slit 7.5 x 100 cm, adhesive	7 / 14	<u>200</u> x 260	528805
U-slit 7.5 x 100 cm, adhesive, with perineal drape	8 / 16	<u>200</u> x 260	528806
U-slit 7.5 x 100 cm, adhesive	6 / 12	<u>225</u> x 320	528808

Colordrape	Qty. dispenser or inliner/PU	Size/cm*	Ref. no.
U-slit 7.5 x 50 cm, adhesive	18 / 72	<u>150</u> x 180	529901

Filmdrape	Qty. dispenser or inliner/PU	Size/cm*	Ref. no.
U-slit 7.5 x 50 cm, adhesive	25 / 100	125 x <u>150</u>	526601

Split Sheet, Bilateral

Mediwell super strong 3-ply	Qty. dispenser or inliner/PU	Size/cm*	Ref. no.
U-slit, dual 40 x 100 cm, adhesive	15 / 15	<u>225</u> x 240	528869

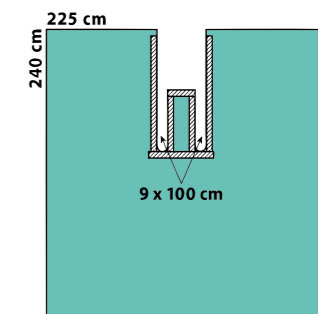

* Underlined numbers mark the adhesive side

Split Sheet with Film Strips

Mediwell super strong 3-ply	Qty. dispenser or inliner/PU	Size/cm	Ref. no.
U-slit, U=7.5 x 100 cm, special adhesive for sensitive skin, 2 film strips 70 x 340, transparent	Pack component	<u>240</u> x 340	528839-9

Split Aperture Drape

Mediwell 2-ply	Qty. dispenser or inliner/PU	Size/cm	Ref. no.
Aperture Ø 6 cm, central, slit 27 cm	Pack component	60 x 60	520057-9

* Underlined numbers mark the adhesive side

Mayo Stand Covers, Back Table Covers

Colordrape

Mayo stand covers made of PE film	Qty. dispenser or inliner/PU	Size/cm	Ref. no.
"Standard", non-woven area 75 x 64 cm, turquoise	20 / 80	80 x 145	547714
"Special", 2-ply Mediwell super, reinforced area 75 x 64 cm	20 / 80	80 x 145	547716
"Super", 2-ply Mediwell absorb area, 75 x 74 cm, for heavy instruments, e.g. orthopaedic procedures, blue	18 / 72	80 x 145	547718

aquamarine

Back table covers/Plain drapes, 2-ply	Qty. dispenser or inliner/PU	Size/cm	Ref. no.
	27 / 81	100 x 150	808823
	18 / 54	150 x 140	808844
	16 / 48	150 x 180	808821
	14 / 42	150 x 200	808869
	12 / 36	150 x 220	808816
	10 / 30	150 x 250	808819

General Surgery



Efficient and safe – from a basic surgical pack up to all-in-one drapes for minimally invasive procedures and complex positioning of the patient.

Our drapes offer high functionality, allow more efficient procedures and guarantee optimum protection of the patient.



Universal Packs

Universal Pack, standard 561088

Inliner: 3 + 4 packs, PU: 7 packs

Cont. and sequence	Size/cm	Qty.	Ref. no.
Plain drape – table cover (wrap)	150 x 180	1	808821
Mayo stand cover	80 x 145	1	547714
Hand towels	25 x 20	4	-/-
OR tape	10 x 50	1	591050
Side drape	75 x 100	2	538811
Foot drape	175 x 180	1	538806
Head drape	150 x 240	1	538807

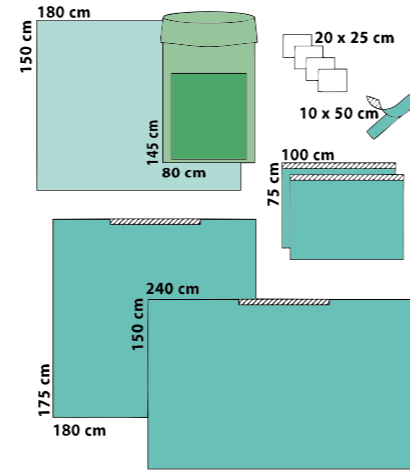

Universal Pack, paediatrics 561007

Inliner: 3 + 4 packs, PU: 7 packs

Cont. and sequence	Size/cm	Qty.	Ref. no.
Plain drape – table cover (wrap)	150 x 180	1	808821
Mayo stand cover	80 x 145	1	547714
Hand towels	25 x 20	4	-/-
OR tape, elastic	10 x 50	1	591151
Side drape	75 x 100	2	538914
Foot drape	175 x 180	1	538916
Head drape	150 x 240	1	538917

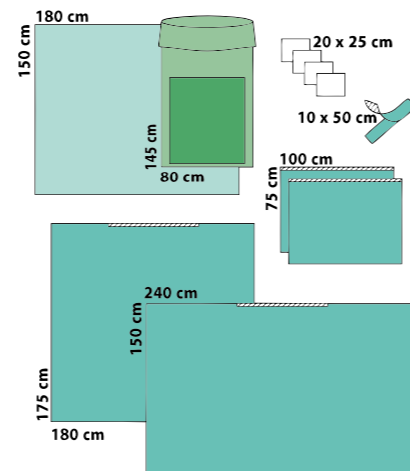

Particularity: with special adhesive and 2.5 cm narrow adhesive zones for children`s skin.

Universal Pack, super 561009

Inliner: 3 + 4 packs, PU: 7 packs

Cont. and sequence	Size/cm	Qty.	Ref. no.
Plain drape – table cover (wrap)	150 x 180	1	808821
Mayo stand cover	80 x 145	1	547714
Hand towels	25 x 20	4	-/-
OR tape	10 x 50	1	591050
Side drape	75 x 100	2	538811
Foot drape	175 x 180	1	538806
Head drape	175 x 300	1	538808



Particularity: with larger head drape

Universal Pack, super + 561027

Inliner: 3 + 4 packs, PU: 7 packs

Cont. and sequence	Size/cm	Qty.	Ref. no.
Plain drape – table cover (wrap)	150 x 200	1	808869
Mayo stand cover	80 x 145	1	547714
Hand towels	25 x 20	4	-/-
OR tape	10 x 50	2	591050
Side drape	100 x 100	2	538813
Foot drape	175 x 180	1	538806
Head drape	175 x 300	1	538808

Particularity: with larger back table cover, side drapes, head drapes and additional OR tape

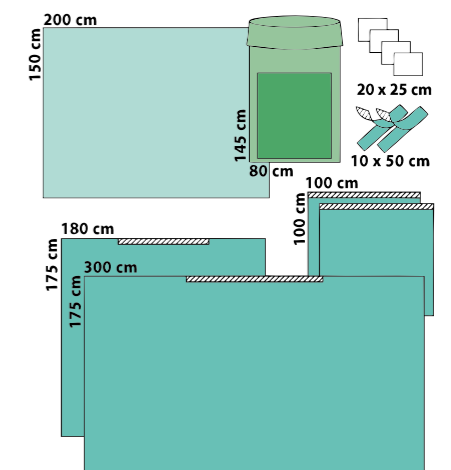

Universal Pack, aquamarine 861088

Inliner: 4 packs, PU: 8 packs

Cont. and sequence	Size/cm	Qty.	Ref. no.
Plain drape – table cover (wrap)	150 x 180	1	808821
OR tape	10 x 50	1	591050
Hand towels	25 x 20	2	-/-
Mayo stand cover	80 x 145	1	547714
Side drapes, 2-ply	75 x 90	2	838823
Foot drape	180 x 175	1	838806
Head drape	150 x 240	1	838807

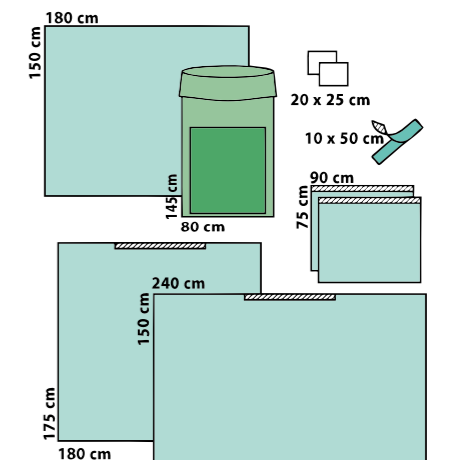

MIS Drapes

MIS Drape **558806-9**

Description	Size/cm
MIS drape, 29 x 32 cm aperture, adhesive	225 x 320

Only available as a non-sterile pack component

MIS Drape with leggings **558884**

Inliner/PU: 7 drapes

Description	Size/cm	Qty.	Ref. no.
MIS drape, 29 x 32 cm aperture, adhesive	225 x 320	1	558884
OR tapes	10 x 50	4	591050
Velcro strips	2/2.5 x 24	2	592525

MIS Pack **563852**

Inliner/PU: 6 packs

Cont. and sequence	Size/cm	Qty.	Ref. no.
Plain drape – table cover (wrap)	150 x 180	1	808821
Mayo stand cover	80 x 145	1	547714
MIS drape with leggings, 29 x 32 cm aperture, adhesive, with integral diathermy pouches, 30 x 50 cm.	225 x 320	1	558875
OR tape	10 x 50	4	591050
Velcro strip	2.5 x 25	2	592525

MIS Drape T-Form **558876-9**

Description	Size/cm
MIS drape with leggings, anaesthesia part with OR tape to fix, 29 x 32 cm aperture, adhesive with 4 integral velcro strips	280/225 x 350

Only available as a non-sterile pack component

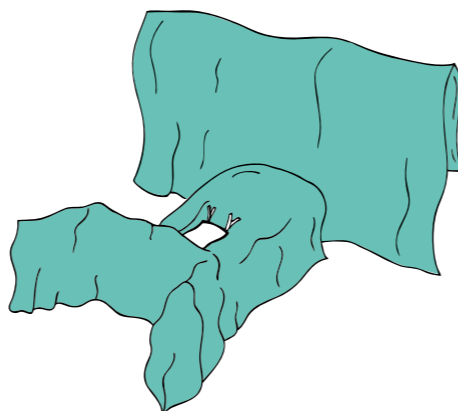
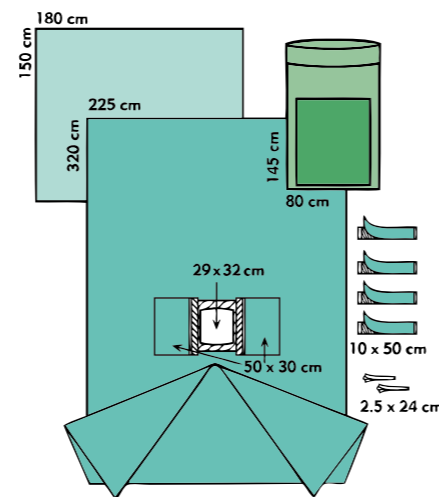
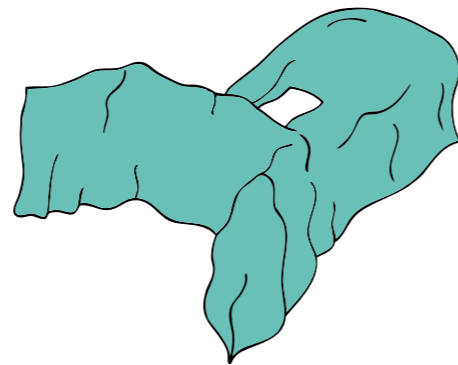
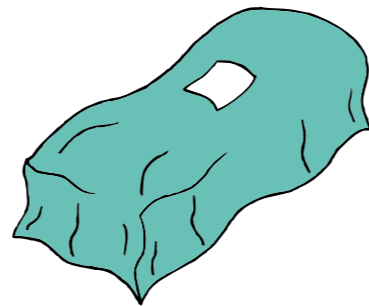

Rectum Drapes and Pack

Rectum with leggings **558885-9**

Description	Size/cm	Qty.	Ref. no.
Rectum drape with leggings, 37 x 37 cm adhesive fenestration and non-adhesive 14 x 16 cm perineal aperture with protective curtain	225 x 320	1	558885
OR tape, transparent, with 7 x 9 cm aperture to reduce in size and securely fix the perineal aperture	20 x 25		592125
Adhesive drape, 2-ply	50 x 50	1	538822

Only available as a non-sterile pack component

Rectum Drape T-Form **558869-9**

Description	Size/cm
Rectum drape with leggings, aperture 29 x 32 cm, adhesive, 2 integral diathermy pouches, with non-adhesive perineal aperture 9 x 17 cm with protective curtain	280/225 x 350

Only available as a non-sterile pack component

Rectum Pack **561030**

Inliner/PU: 6 packs

Cont. and sequence	Size/cm	Qty.	Ref. no.
Plain drape – table cover (wrap)	150 x 200	1	808869
Mayo stand cover	80 x 145	1	547714
Hand towels	20 x 25	2	-/-
OR tapes	10 x 50	4	591050
OR tapes	5 x 12.5	4	590512
Rectum drape with leggings, adhesive 29 x 32 cm aperture, and 9 x 9 cm non-adhesive perineal aperture with protective curtain	225 x 320	1	558867

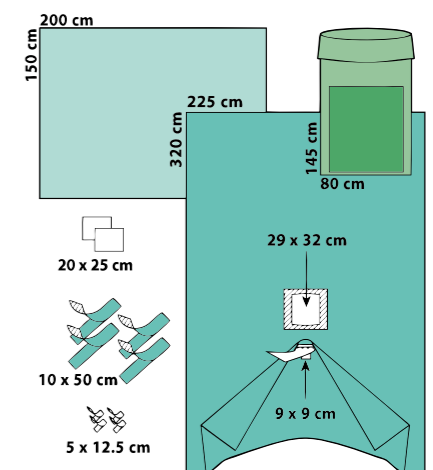
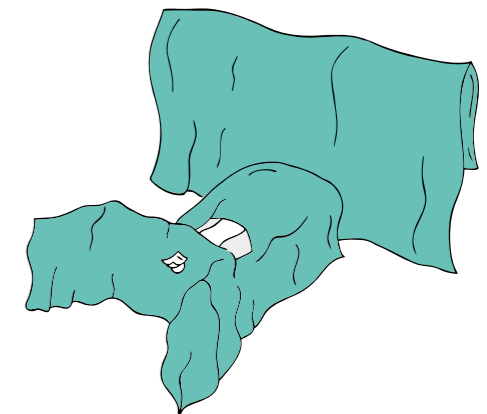
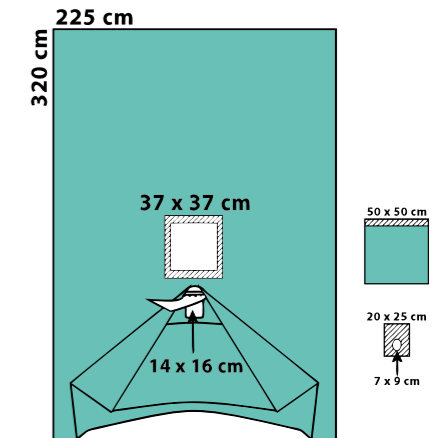

Strumectomy Packs

Strumectomy Pack, standard 561302

Inliner: 4 packs, PU: 8 packs

Cont. and sequence	Size/cm	Qty.	Ref. no.
Plain drape – table cover (wrap)	150 x 180	1	808821
Mayo stand cover	80 x 145	1	547714
Hand towels	25 x 20	4	-/-
OR tape	10 x 50	1	591050
Velcro strip, adhesive	2/2.25 x 24	1	592525
Foot drape	180 x 200	1	538810
Split sheet, U=65 cm	150 x 280	1	528804

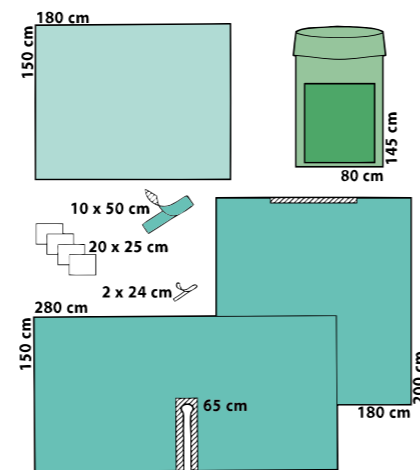

U-Drape Pack 1 561119

Inliner: 5 packs, PU: 10 packs

Cont. and sequence	Size/cm	Qty.	Ref. no.
Plain drape – table cover (wrap)	150 x 200	1	808869
Hand towel	25 x 20	1	-/-
Mayo stand cover	80 x 145	1	547714
Split sheet, U=7.5 x100 cm	200 x 300	1	528863
Split sheet, U=65 x 45 cm	150 x 270	1	528864

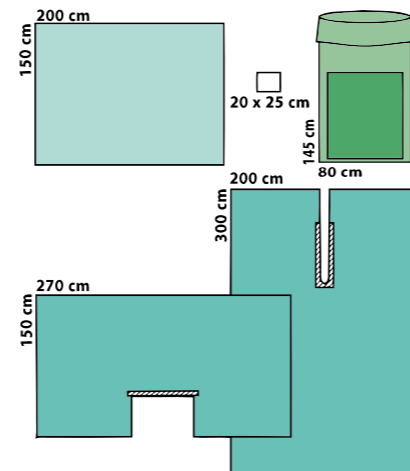

U-Drape Pack 2 563770

Inliner: 5 packs, PU: 10 packs

Cont. and sequence	Size/cm	Qty.	Ref. no.
Plain drape – table cover (wrap)	150 x 200	1	808869
Mayo stand cover	80 x 145	1	547714
Hand towel	25 x 20	1	-/-
Split sheet, U=30 x 80 cm	200 x 300	1	528816
Split sheet, U=65 x 45 cm	150 x 270	1	528864

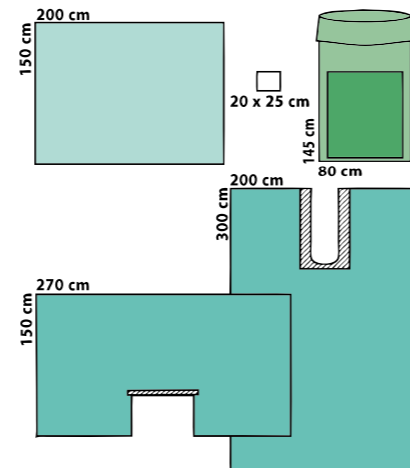

Split Sheet Packs

Split Sheet Pack, standard 561112

Inliner: 3 + 4 packs, PU: 7 packs

Cont. and sequence	Size/cm	Qty.	Ref. no.
Plain drape – table cover (wrap)	150 x 180	1	808821
Mayo stand cover	80 x 145	1	547714
Hand towels	25 x 20	4	-/-
Bottom drape, Mediwell 3-ply	150 x 180	1	501518
Split sheet, U=7.5 x 100 cm	200 x 260	1	528805
Adhesive drape	150 x 240	1	538807

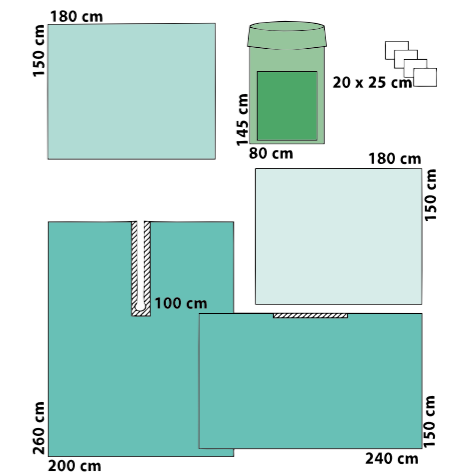

Split Sheet Pack, aquamarine 861112

Inliner: 3 + 4 packs, PU: 7 packs

Cont. and sequence	Size/cm	Qty.	Ref. no.
Plain drape – table cover (wrap)	150 x 180	1	808821
Mayo stand cover	80 x 145	1	547714
Hand towels	25 x 20	2	-/-
Plain drape, 2-ply, as bottom drape	150 x 180	1	808821
Split sheet, U=7.5 x 100 cm	200 x 260	1	828805
Adhesive drape	150 x 240	1	838807

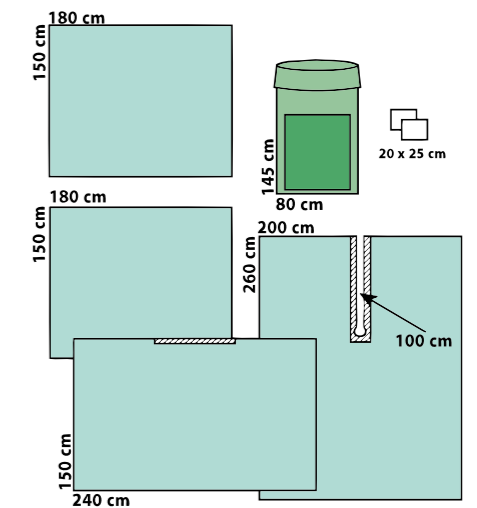

Cardio/Thoracic, Vascular Surgery



With heart and mind: Our cardiovascular solutions fulfil the highest quality requirements in heart surgery. Innovative OR drapes provide optimum flexibility and safety – for established and for new surgical methods e.g. hybrid surgery.

Standard and customised OR drapes for angiography complete our product portfolio.

You will find further products in our separate cardio-surgery and angiography brochure.



Cardio/Thoracic Drapes

Cardio/Thoracic Drape

558914

Inliner/PU: 4 drapes

Description	Size/cm	Qty.
T-form, anaesthesia part with double film thickness, 3 integral adhesive strips to fix 33 x 28 cm diathermy pouch and clamp strip. Thoracic part with 33 x 40 cm fenestration with integral incision film, 2 triple chamber diathermy pouches and 50 x 50 cm adhesive drape.	300/225 x 300	1

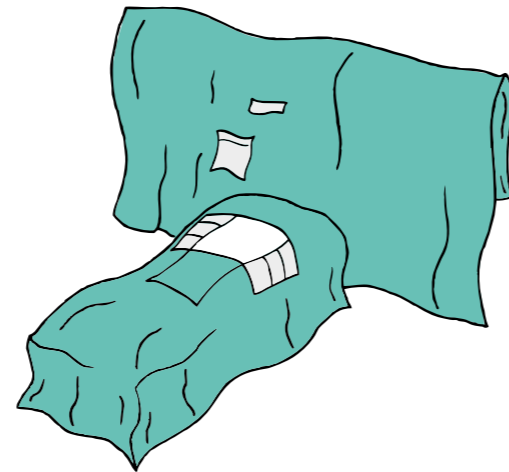

Cardio/Thoracic Drape

558993-9

Description	Size/cm	Qty.	Ref. no.
T-form, anaesthesia part with double film thickness, 3 integral adhesive strips to fix, 2 velcro fasteners and reinforced clamp strip. Thoracic part with self adhesive slit 100 cm	300/225 x 300	1	558993
Velcro strips	2/2.5 x 50	2	592550

Only available as a non-sterile pack component

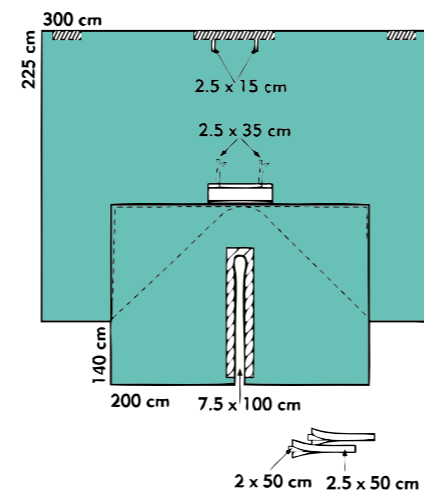

Bypass Packs

Cardiovascular/Bypass Pack

561559

Inliner/PU: 3 packs

Cont. and sequence	Size/cm	Qty.	Ref. no.
Plain drape – table cover (wrap)	150 x 180	1	808821
Mayo stand cover	80 x 145	1	547714
Hand towels	20 x 25	4	-/-
Foot covers, 2-ply	30 x 40	2	589950
Diathermy pouch	33 x 28	1	583330
OR tape, elastic	10 x 50	2	591151
Bottom drape, Mediwell	150 x 180	1	501518
Varicose vein drape, U=7.5 x 100 cm	200 x 260	1	528806
Cardiovascular drape	300/225 x 300	1	558914

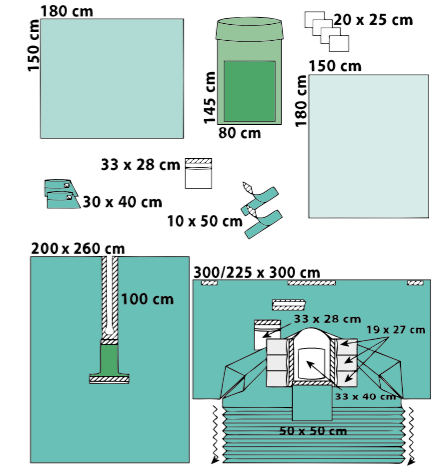

Bypass Pack

561568

Inliner: 3 packs, PU: 6 packs

Cont. and sequence	Size/cm	Qty.	Ref. no.
Plain drape – table cover (wrap)	150 x 180	1	808821
Mayo stand cover	80 x 145	1	547714
Hand towels	20 x 25	4	-/-
Foot covers, 2-ply	30 x 40	2	589950
Diathermy pouch	33 x 28	1	583330
OR tape, elastic	10 x 50	2	591151
Bottom drape, Mediwell	150 x 180	1	501518
Varicose vein drape, U=7.5 x 100 cm	200 x 260	1	528806
Cardiovascular drape	300/225 x 300	1	558998

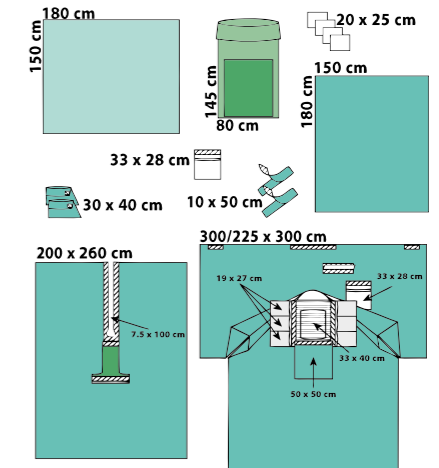

Bypass Pack

561575

Inliner/PU: 2 packs

Cont. and sequence	Size/cm	Qty.	Ref. no.
Steriflex overwrap	120 x 120	1	901212
Plain drape – table cover (wrap)	150 x 180	1	808821
OR gown, reinforced	XL = 150	4	464417
Mayo stand cover	80 x 145	2	547714
Mayo stand cover	80 x 145	1	547716
Varicose vein drape, U=7.5 x 100 cm	200 x 260	1	528806
Foot covers, 2-ply	53 x 106	2	588813
OR tape	10 x 50	2	591050
Adhesive drapes, 2-ply	75 x 90	2	538823
Cardiovascular drape	300/225 x 350	1	559000
Diathermy pouches	33 x 28	2	583330
Plain drape, 2-ply	75 x 90	1	508824

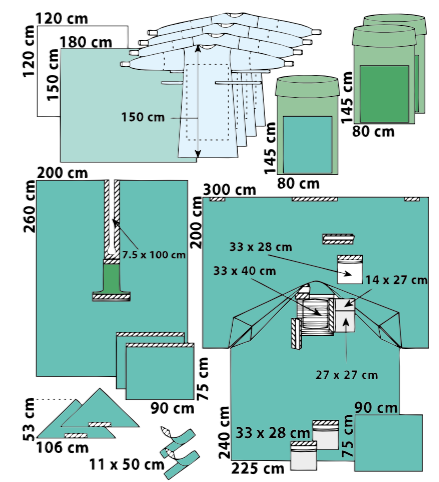

Particularity: with additional overwrap, extra standard and reinforced Mayo stand covers

Hybrid Drapes

Cardio/Angiography Drape **559060-9** with thoracic and 2 femoral apertures

Description	Size/cm
with 3 integral, transparent wide film strips, 2 x 100 x 400 cm and 1 x 100 x 300 cm, 2 apertures 12 x 20 cm, 1 aperture 35 x 65 cm with incision film, adhesive, reinforcement 75 x 120 cm, 4 velcro strips and 2 diathermy pouches	300 x 500

Only available as a non-sterile pack component

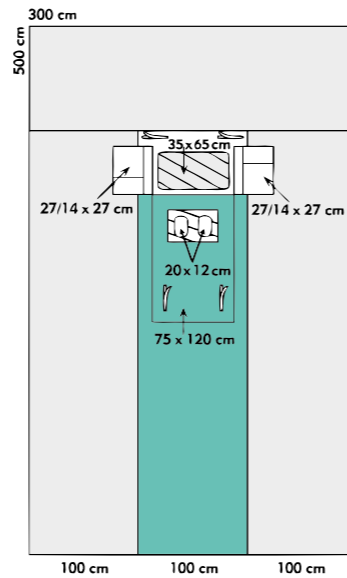

Cardio/Angiography Drape **559081-9**

Description	Size/cm
with 3 integral, transparent wide film strips, 2 x 100 x 400 cm and 1 x 100 x 300 cm, aperture 44 x 90 cm with incision film, adhesive, reinforcement 75 x 280 cm, 2 velcro strips	300 x 500

Only available as a non-sterile pack component

Note: also available without lateral slits, article number 559181-9, as a non-sterile pack component

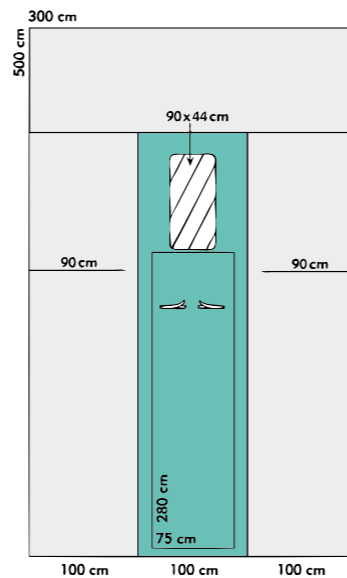

Supplementary Products

Varicose Vein Drape **528806**

Inliner: 8 drapes, PU: 16 drapes

Description	Size/cm	Qty
100 cm U-slit, adhesive and adhesive perineal drape made of Colordrape, with elastified sides	200 x 260	1

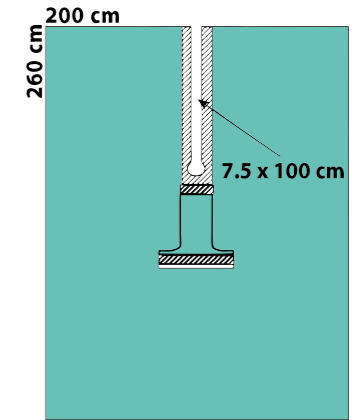

Foot Covers **589950**

Dispenser 30 pairs, PU: 180 pairs

Description	Size/cm	Qty
Foot cover with adhesive zone to fix	23-32 x 42	2

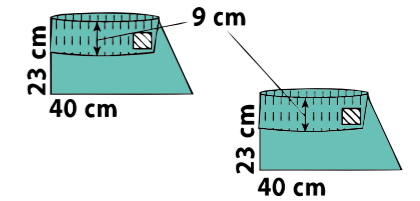

Foot Covers **589951**

Dispenser 50 pairs, PU: 150 pairs

Description	Size/cm	Qty
Foot cover made of transparent film drape with adhesive zone to fix	25-34 x 45	2

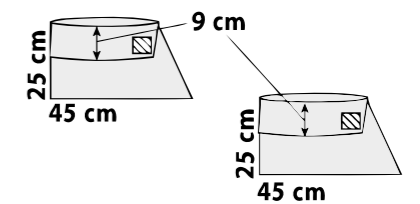

Pacemaker Drape **559054-9**

Description	Size/cm
Angiography drape with 2 integral, transparent film strips, aperture 12 x 12 cm, adhesive with fenestrated incision film 10 x 10 cm and Mediwell absorb reinforcement	240 x 320

Only available as a non-sterile pack component

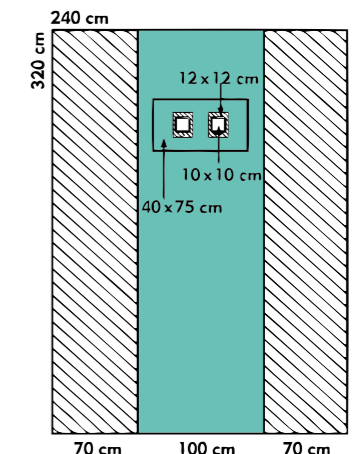

Angiography Drapes

Angiography Drape

558805

Inliner: 5 drapes, PU: 10 drapes

Description	Size/cm	Qty.	Ref. no.
Transparent film strip 70 cm, 2 apertures 6 x 8 cm, adhesive and absorbent reinforcement 75 x 100 cm	220 x 300	1	558805
OR tape strips	10 x 25	1	591025
Hand towel	20 x 25	1	-/-

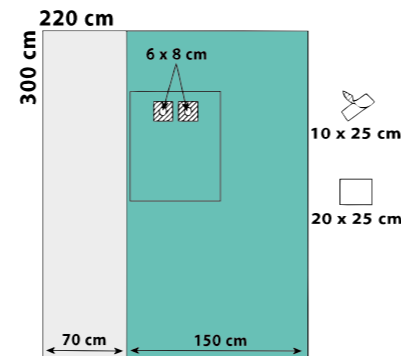

Angiography Drape

558956

Inliner: 7 drapes, PU: 17 drapes

Description	Size/cm	Qty.	Ref. no.
Angiography drape with 2 integral, transparent wide film strips, 50 cm, 2 apertures 6 x 8 cm, adhesive and absorbent non-woven reinforcement 75 x 100 cm	250 x 320	1	558956

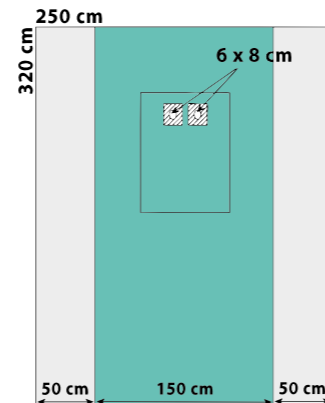

Angiography Drape, aquamarine

858805

Inliner: 11 drapes, PU: 22 drapes

Description	Size/cm	Qty.	Ref. no.
Angiography drape with transparent film side strip 70 cm, 2 apertures 6 x 8 cm, adhesive and absorbent reinforcement 75 x 100 cm	220 x 300	1	858805
OR tape strips	10 x 25	1	591025
Hand towel	20 x 25	1	-/-

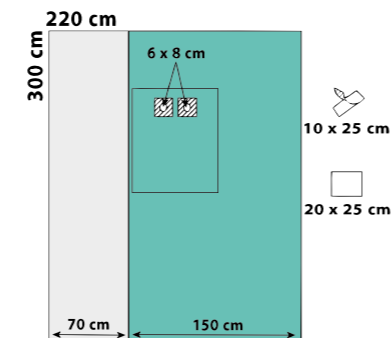

Angiography Drape

558918-9

Description	Size/cm
Angiography drape with transparent film strip 70 cm, 2 apertures 6 x 8 cm, adhesive and absorbent reinforcement 75 x 100 cm	220 x 340

Only available as a non-sterile pack component

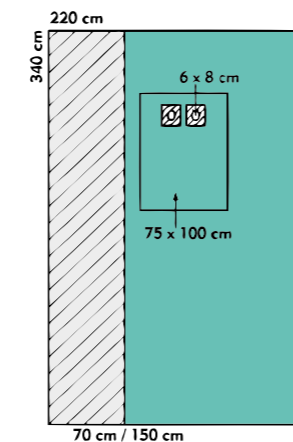

Angiography Drape

559053-9

Description	Size/cm
Angiography drape with 2 transparent film strips 70 cm, 2 apertures Ø 10 cm, adhesive with fenestrated incision film Ø 8 cm and absorbent reinforcement 75 x 100 cm	290 x 380

Only available as a non-sterile pack component

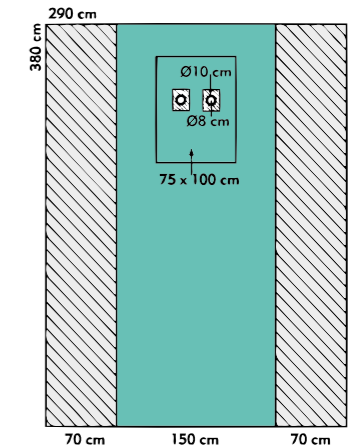

Angiography Drape

559071-9

Description	Size/cm
Angiography drape with 2 transparent film strips 70 cm, 2 apertures 8 x 6 cm, adhesive and absorbent reinforcement 75 x 100 cm	215 x 340

Only available as a non-sterile pack component

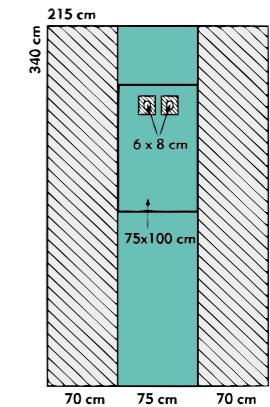

Angiography Drape

559059-9

Description	Size/cm
Angiography drape with 3 transparent film strips 70 cm, 2 apertures 8 x 6 cm, adhesive and absorbent reinforcement 75 x 100 cm	240 x 310

Only available as a non-sterile pack component

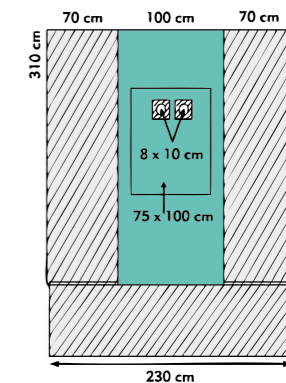

4 Femoral Radial Angiography Drape

559100-9

Description	Size/cm
Angiography drape with 2 transparent film strips 70 x 240 cm, 2 apertures Ø 12 cm (femoral), adhesive, and 2 apertures Ø 10 cm (radial) with 7 cm fenestrated incision film, adhesive, and absorbent reinforcement	280 x 390

Only available as a non-sterile pack component

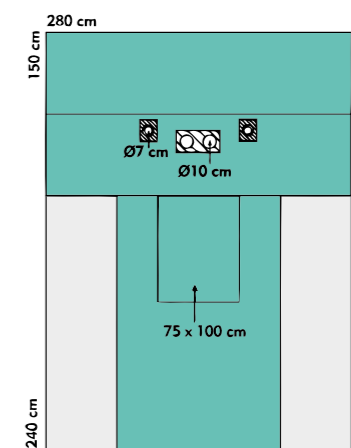

Orthopaedics, Traumatology



Our products offer highest quality for orthopaedics and traumatological surgeries e.g. joint replacement. Easy handling guarantees high application comfort.

Furthermore, a large selection of extremity drapes with and without pouch are available in a wide range of models.

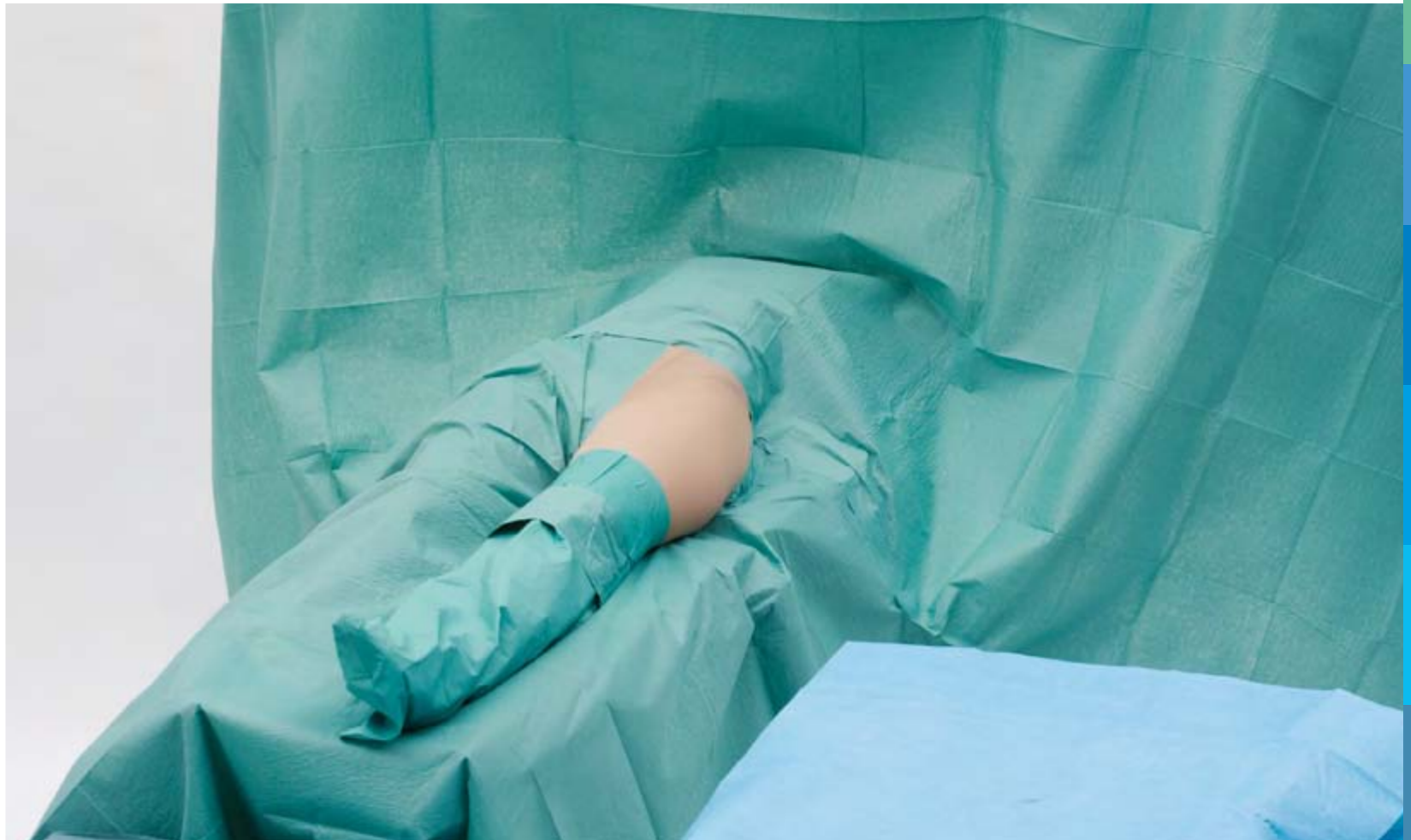

Split Sheet Pack

Split Sheet Pack, standard

561112

Inliner: 3 + 4 packs, PU: 7 packs

Cont. and sequence	Size/cm	Qty.	Ref. no.
Plain drape – table cover (wrap)	150 x 180	1	808821
Mayo stand cover	80 x 145	1	547714
Hand towels	25 x 20	4	-/-
Bottom drape, Mediwell 3-ply	150 x 180	1	501518
Split sheet, U=7.5 x 100 cm	200 x 260	1	528805
Adhesive drape	150 x 240	1	538807

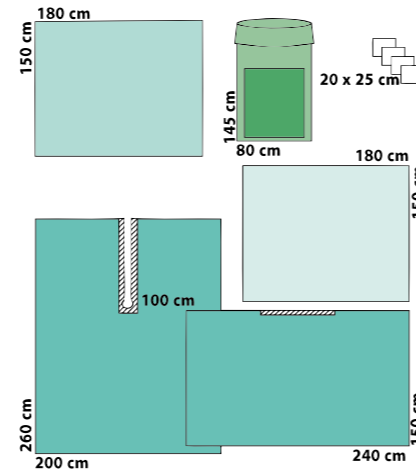

Extremity Drapes

Extremity Drape

518810

Inliner: 6 drapes, PU: 12 drapes

Description	Size/cm	Qty.
Extremity drape with Ø 7 cm elastic aperture with cable/tube holder	225 x 320	1

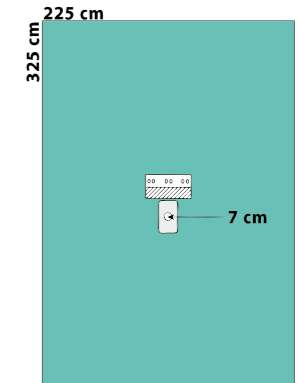

Extremity Drape

518864

Inliner: 6 drapes, PU: 12 drapes

Description	Size/cm	Qty.
Extremity drape with Ø 7 cm elastic aperture	245 x 325	1

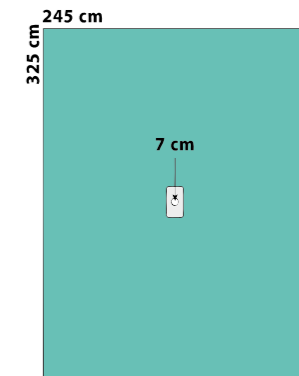

Extremity Drape

518820

Inliner: 8 drapes, PU: 16 drapes

Description	Size/cm	Qty.
Extremity drape, 2-ply, with Ø 7 cm elastic aperture	200 x 300	1

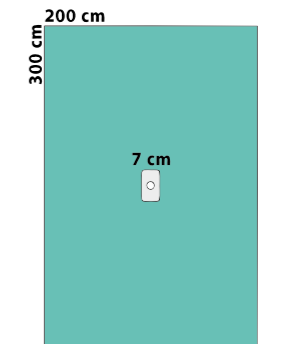

Extremity Drape T-Form

518861-9

Description	Size/cm
Extremity drape in T-form with 7 cm elastic aperture	280/225 x 450

Only available as a non-sterile pack component

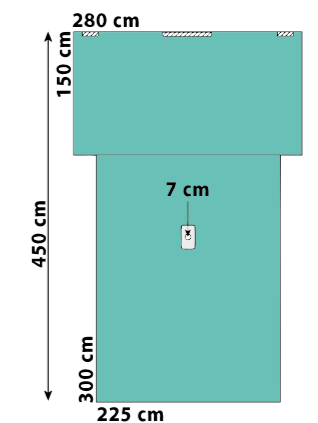

Extremity Packs

Extremity Pack, standard

561107

Inliner: 4 packs, PU: 8 packs

Cont. and sequence	Size/cm	Qty.	Ref. no.
Plain drape – table cover (wrap)	150 x 180	1	808821
Mayo stand cover	80 x 145	1	547714
Hand towels	25 x 20	4	-/-
Bottom drape	100 x 150	1	508803
Adhesive drape	75 x 75	1	538801
OR tape	10 x 50	2	591050
Extremity drape with Ø 7 cm elastic aperture, cable/tube holder	225 x 325	1	518810

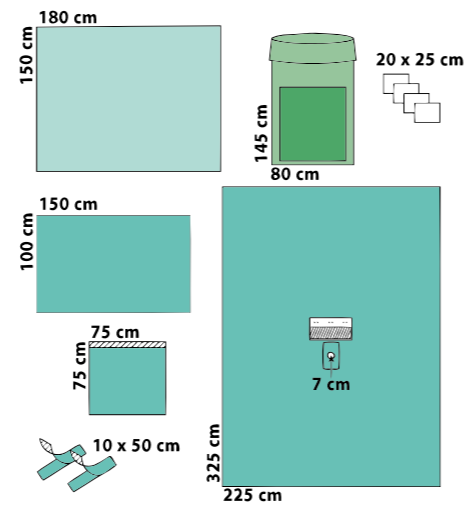

Extremity Pack, standard 2

561117

Inliner: 3 + 4 packs, PU: 7 packs

Cont. and sequence	Size/cm	Qty.	Ref. no.
Plain drape - table cover (wrap)	150 x 180	1	808821
Mayo stand cover	80 x 145	1	547714
Hand towels	25 x 20	4	-/-
Bottom drape, 2-ply	150 x 180	1	508821
Stockinette	33 x 73	1	583355
OR tape, film	11 x 50	2	591150
Extremity drape with Ø 7 cm elastic aperture, cable/tube holder	225 x 325	1	518810

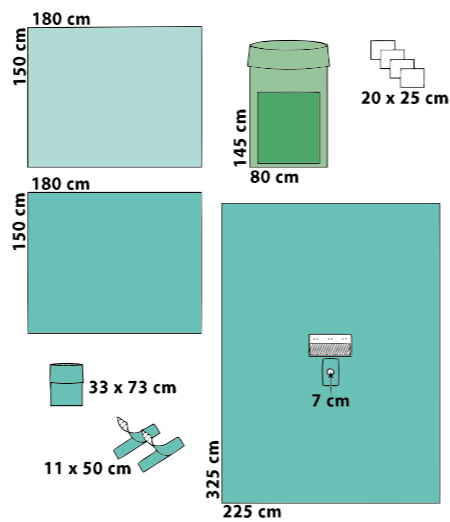

Particularity: with Stockinette

Arthroscopy Drapes

Arthroscopy Drape

518813

Inliner: 6 drapes, PU: 12 drapes

Description	Size/cm	Qty.
Arthroscopy drape with cable/tube holder and fluid collection pouch with drainage port	225 x 325	1

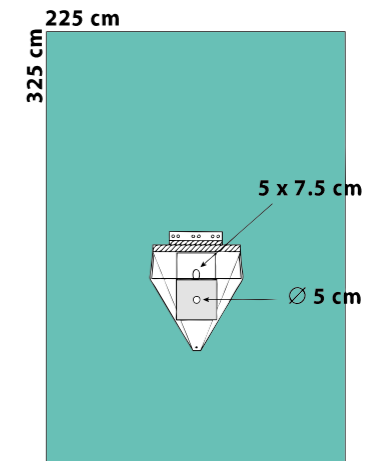

Arthroscopy Drape "small"

518853

Inliner: 12 drapes, PU: 24 drapes

Description	Size/cm	Qty.
Arthroscopy drape "small", 2-ply, with cable/tube holder and fluid collection pouch with drainage port	200 x 300	1

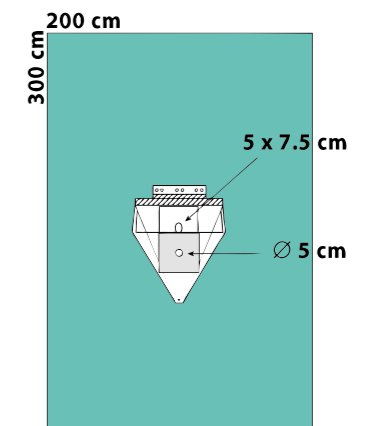

Arthroscopy Packs

Arthroscopy Pack, standard 1 561105

Inliner: 5 packs, PU: 10 packs

Cont. and sequence	Size/cm	Qty.	Ref. no.
Medinop overwrap	85 x 100	1	628510
Mayo stand cover	80 x 145	1	547714
Hand towels	20 x 25	4	-/-
Stockinette, 2-ply	33 x 73	1	583355
OR tape, film	11 x 50	2	591150
Extremity drape with Ø 7 cm elastic aperture, cable/tube holder	225 x 325	1	518810

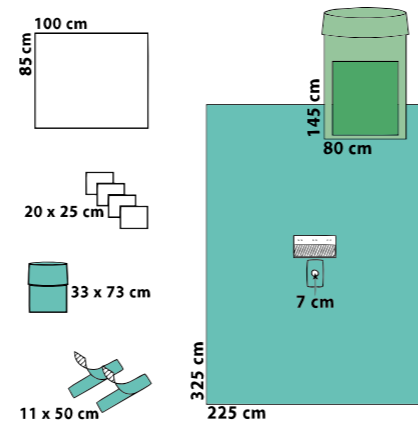

Arthroscopy Pack with fluid collection pouch 561149

Inliner: 4 packs, PU: 8 packs

Description	Size/cm	Qty.	Ref. no.
Plain drape – table cover (wrap)	150 x 180	1	808821
Mayo stand cover	80 x 145	1	547714
Plain drape, 2-ply	150 x 180	1	508821
Stockinette	33 x 73	1	583355
OR tape, film	11 x 50	2	591150
Camera tube cover, telescopically	13 x 250	1	581323
OR tape, elastic	11 x 50	2	591150
Arthroscopy drape with cable/tube holder and fluid collection pouch with drainage port	225 x 325	1	518813

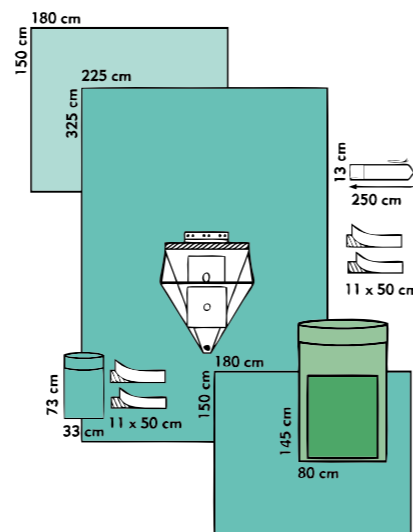

Arthroscopy Pack, standard 3 563035

Inliner: 3 packs, PU: 6 packs

Cont. and sequence	Size/cm	Qty.	Ref. no.
Medinop overwrap	85 x 100	1	628510
Hand towels	30 x 40	2	-/-
OR gown, standard	XL = 150	1	464416
OR gown, reinforced	XL = 150	1	464417
Mayo stand cover	80 x 145	1	547714
Stockinette, 2-ply	33 x 73	1	583355
OR tape, film	11 x 50	2	591150
Camera tube cover, telescopically	13 x 250	1	581323

Extremity drape, 2-ply, with Ø 7 cm elastic aperture, decentral and integral velcro strip

200 x 300 1 518819

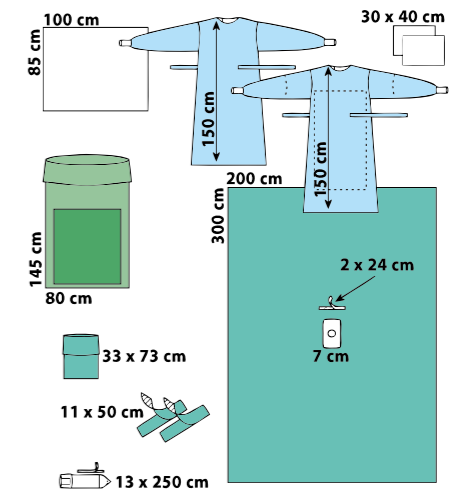

Arthroscopy Pack, aquamarine 861122

Inliner: 5 packs, PU: 10 packs

Cont. and sequence	Size/cm	Qty.	Ref. no.
Plain drape – table cover (wrap)	150 x 180	1	808821
Mayo stand cover	80 x 145	1	547714
Stockinette, 2-ply	33 x 73	1	883355
OR tape, film	11 x 50	2	591150
Camera tube cover, telescopically	13 x 250	1	581323
Velcro strip	2/2,5 x 24	1	592525
Extremity drape, with Ø 7 cm elastic aperture	200 x 300	1	818820

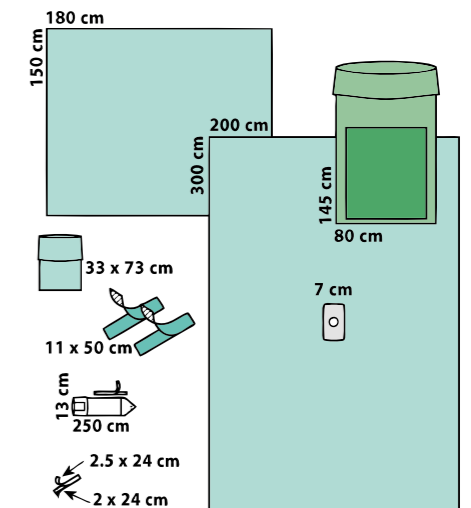

Shoulder Drape

Shoulder Drape "Beach Chair" 518835

with integral fluid collection pouch
Inliner: 5 drapes, PU: 10 drapes

Description	Size/cm	Qty.
Shoulder drape, pearshaped, 11.5 x 12.5 cm elastic aperture, central, with 5.5 x 20 cm adhesive zone to fix to the patient side; fluid collection pouch with drainage port and pliable rim strip and 3 integral velcro strips on the front. For procedures in the seated position.	380 x 225	1

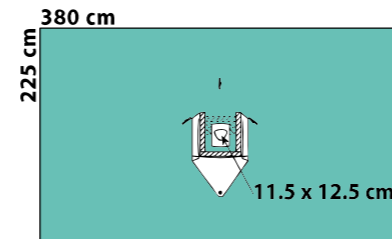

Hand Surgery Drapes

Hand Surgery Drape 518844

PU: 20 drapes

Description	Size/cm	Qty.
Hand surgery drape, 2-ply, T-form, with integral arm table cover and elastic aperture Ø 3 cm	360/150 x 330	10

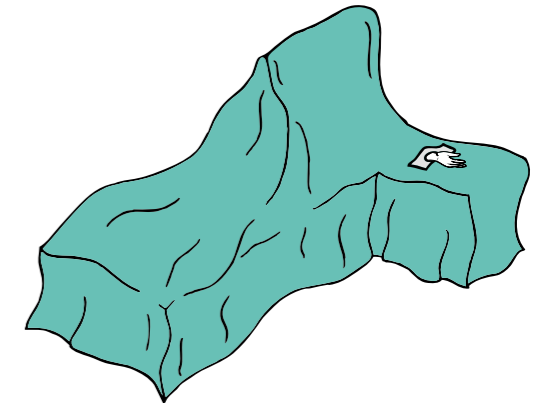

Hand Surgery Drape 518845

PU: 20 drapes

Description	Size/cm	Qty.
Hand surgery drape, 2-ply, T-form, with integral arm table cover and elastic aperture Ø 3 cm	360/160 x 280	10

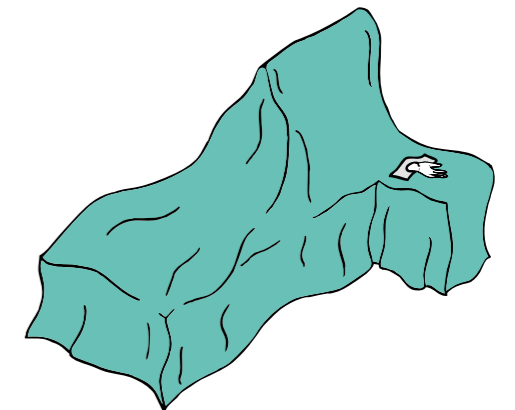

Hand Surgery Drape, aquamarine 818848-9

Description	Size/cm
Hand surgery drape, 2-ply, T-form, with integral arm table cover with elastic aperture Ø 3 cm and absorbent non-woven reinforcement	360/150 x 295

Only available as a non-sterile pack component

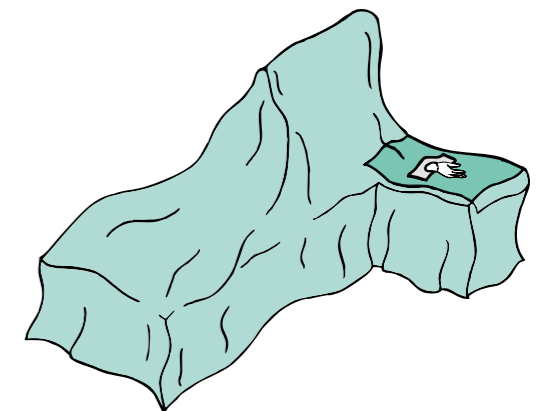

Hand/Foot Pack and Drapes

Hand/Foot Pack 564185

Inliner: 5 packs, PU: 10 packs

Cont. and sequence	Size/cm	Qty.	Ref. no.
Plain drape – table cover (wrap)	150 x 200	1	808869
Mayo stand cover	80 x 145	1	547714
Hand/Foot drape	225 x 300	1	518815

Particularity: with larger back table cover

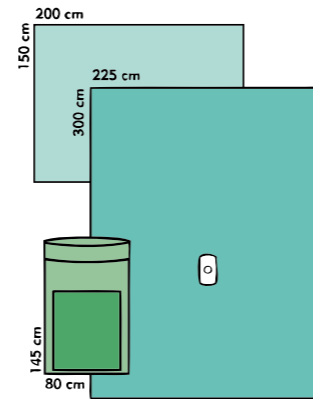

Hand/Foot Drape 518815

Inliner: 6 drapes, PU: 12 drapes

Description	Size/cm	Qty.
Extremity drape with Ø 3 cm elastic aperture, decentral	225 x 300	6

Hand/Foot Drape, aquamarine 818815-9

Description	Size/cm
Extremity drape with Ø 3 cm elastic aperture, decentral	225 x 300

Only available as a non-sterile pack component

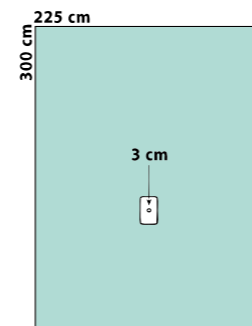

Extremity Drape "small" 518825

Inliner: 15 packs, PU: 60 packs

Description	Size/cm	Qty.
Extremity drape, 2-ply, with Ø 4 cm elastic aperture	100 x 160	15

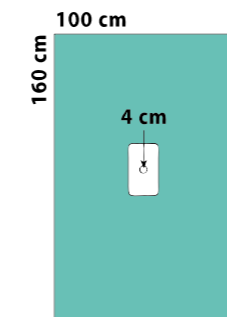

Dual Extremity Drape 518832-9

for procedures on both feet

Description	Size/cm
Dual extremity drape, 2-ply, with Ø 4 cm elastic apertures, decentral	225 x 320

Only available as a non-sterile pack component

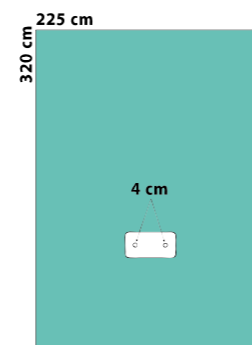

Hip Pack and Drape

Hip Pack, standard 561110

Inliner: 2 + 3 packs, PU: 5 packs

Cont. and sequence	Size/cm	Qty.	Ref. no.
Plain drape – table cover (wrap)	150 x 180	1	808821
Mayo stand cover	80 x 145	1	547714
Hand towels	20 x 25	4	-/-
Plain drape, 2-ply	75 x 90	1	508824
Plain drape	150 x 180	1	508801
Stockinette, 2-ply	35 x 120	1	583311
OR tape, film	11 x 50	2	591150
Split sheet, U=7.5 x 100 cm	200 x 260	1	528805
Adhesive drape	175 x 300	1	538808

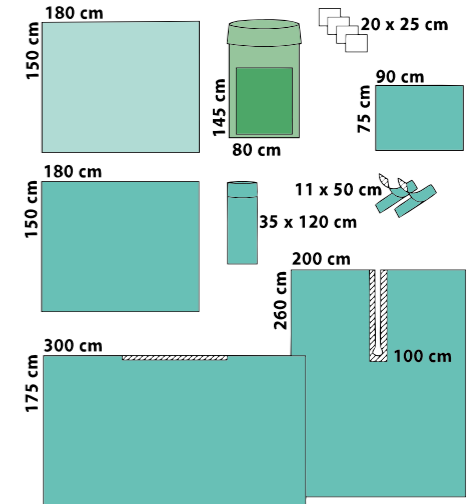

Hip Drape T-Form 518890-9

Description	Size/cm
Hip drape T-form, with Ø 20 cm elastic aperture with adhesive zone and 2 integral pouches 80 x 100 cm	280/225 x 390

Only available as a non-sterile pack component

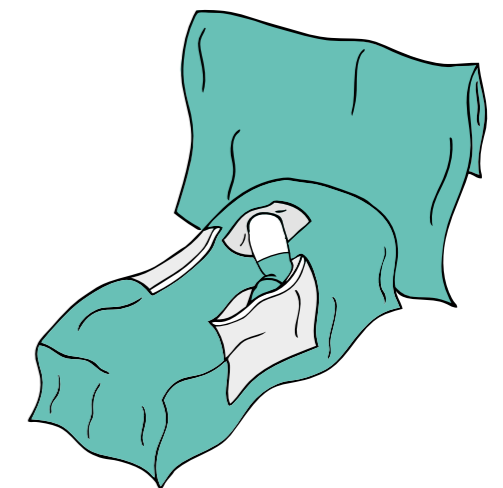

Vertical Isolation Drapes and Packs

Vertical Isolation Drape Pack 1 563696

Inliner: 10 packs, PU: 20 packs

Cont. and sequence	Size/cm	Qty.	Ref. no.
Plain drape – table cover (wrap)	150 x 180	1	808821
Mayo stand cover	80 x 145	1	547714
Hand towels	25 x 20	4	-/-
Vertical isolation drape	330 x 244	1	556610

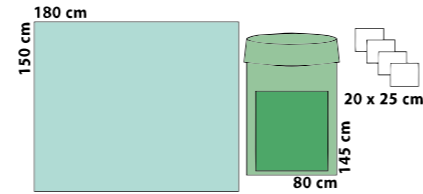

Vertical Isolation Drape 556610

Inliner/PU: 10 drapes

Description	Size/cm	Qty.
Vertical isolation drape with 40.6 x 30.5 cm aperture with integral incision film; 2 diathermy pouches and velcro strips; fluid collection pouch with sieve and drainage port; 1.3 x 330 cm adhesive zone	330 x 244	1

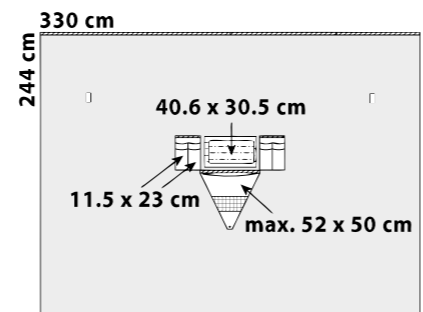

Vertical Isolation Drape Pack 2 563675

Inliner: 10 packs, PU: 7 packs

Cont. and sequence	Size/cm	Qty.	Ref. no.
Plain drape – table cover (wrap)	150 x 180	1	808821
Mayo stand cover	80 x 145	1	547714
Hand towels	25 x 20	4	-/-
Vertical isolation drape	330 x 244	1	556611

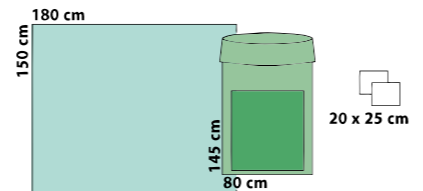

Vertical Isolation Drape 556611

Inliner: 9 drapes, PU: 18 drapes

Description	Size/cm	Qty.
Vertical isolation drape with 86.4 x 25.4 cm aperture with integral incision film; 2 diathermy pouches and velcro strips; fluid collection pouch with sieve and drainage port; 1.3 x 330 cm adhesive zone	330 x 244	1

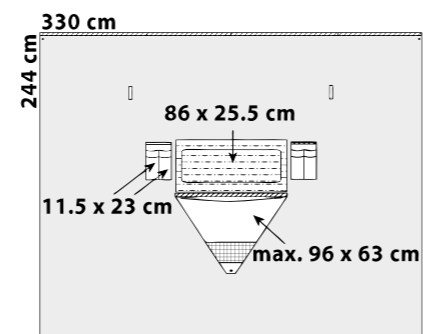

Supplementary Products

Velcro Strip 592525

Dispenser, PU: 600 pcs.

Description	Size/cm	Qty./disp.	Ref. no.
OP-velcro strip	2/2.5 x 24	100	592525

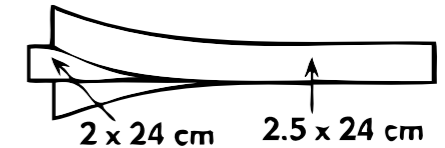

Camera Tube Covers dispenser

Description	Size/cm	Qty./disp.	Ref. no.
Camera tube cover, reverse PU: 210 covers	13 x 250	35	581322
Camera tube cover, telescopically PU: 192 covers	13 x 250	32	581323
Camera tube cover, telescopically PU: 192 covers	13 x 250	32	581324
Camera tube cover, telescopically PU: 150 covers	13 x 250	25	581325
Camera tube cover, telescopically PU: 120 covers	13 x 250	30	581825

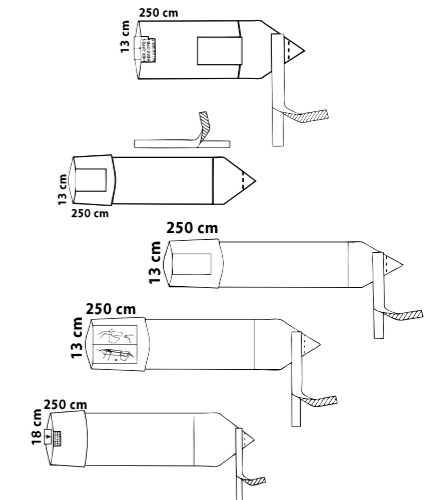

Fluid Collection Pouches

Dispenser, PU: 100 pouches

Description	Size/cm	Qty./disp.	Ref. no.
For hip procedures	68 x 100	25	588010

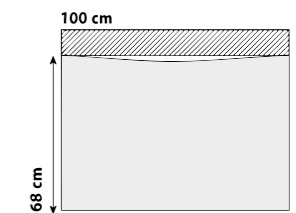

Fluid Collection Pouches for Arthroscopies

Dispenser, PU: 50 pouches

Description	Size/cm	Qty./disp.	Ref. no.
Shoulder, with U = 50 cm adhesive and 2 drainage ports	59/82 x 76	25	589978

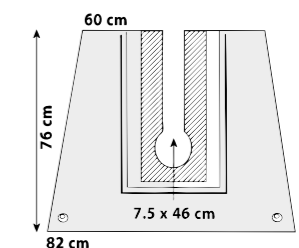

Supplementary Products

Elastic Inlets, non-sterile

Description	Size/cm	Qty.	Ref. no.
Aperture Ø 7 cm, central Inliner: 100 pcs., PU: 1.000 pcs.	25 x 40	100	582540
Aperture Ø 7 cm, central Inliner: 50 pcs., PU: 500 pcs.	40 x 40	50	584040

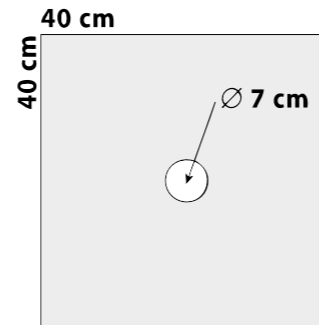

Image Intensifier Covers

Dispenser, PU: 140 pcs.

Description	Size/cm	Qty./disp.	Ref. no.
with drawstring	75 x 65	35	587565

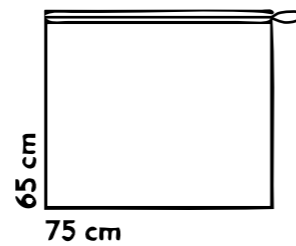
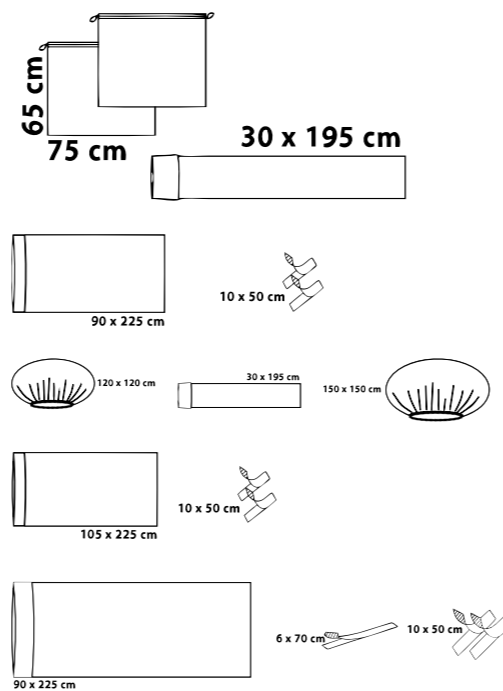

Image Intensifier Covers and Packs

Description	Qty./disp.	Ref. no.
Pack 1, for Philips equipment, 3-part PU: 72 packs	18	565803
Pack 2, for Siemens equipment, 1-part with 2 tapes PU: 40 packs	10	565804
Pack 3, for Philips BV29 equipment, 3-part PU: 24 packs	24	565805
Pack 4, for Siemens ISO-C, 1-part with 2 OR tapes PU: 50 packs	50	565851
Pack 5, for Siemens equipment, 1-part with 3 OR tapes PU: 40 packs	10	565856



Stockinettes dispenser

Description	Size/cm	Qty./disp.	Ref. no.
2-ply + 2 film tapes PU: 160 stockinettes	35 x 73	40	583355
2-ply + 2 film tapes PU: 100 stockinettes	35 x 120	25	583311
2-ply + special tapes PU: 120 stockinettes	17 x 75	30	588827
US model PU: 150 stockinettes	23 x 80	25	580001
US model PU: 90 stockinettes	23 x 110	15	580002
US model PU: 68 stockinettes	32 x 120	17	580003

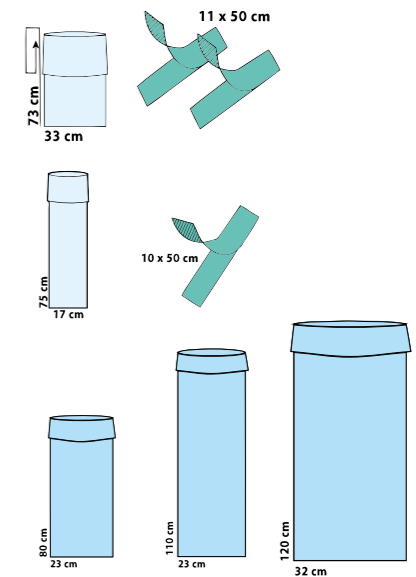

Stool Covers dispenser

Description	Size/cm	Qty./disp.	Ref. no.
Mediwell super, 2-ply PU: 90 covers	75 x 75	15	588875
Mediwell super, 2-ply elastified PU: 210 covers	60 x 60	35	588860

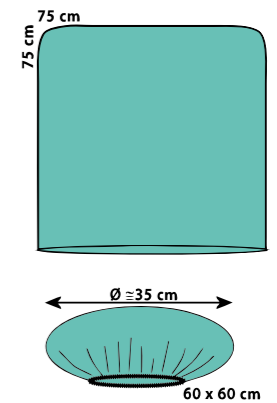

OR Tapes dispenser

Description	Size/cm	Qty./disp.	Ref. no.
non-woven, standard PU: 780 tapes	10 x 50	130	591050
non-woven, elastic PU: 750 tapes	10 x 50	125	591151
film PU: 660 tapes	11 x 50	110	591150

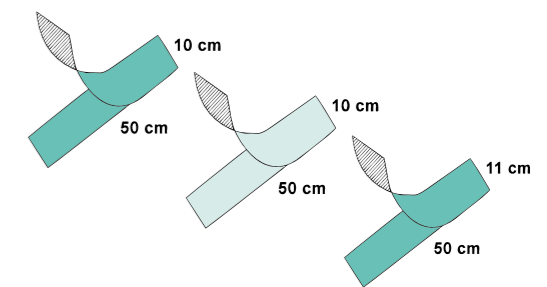

Urology



Indication adapted solutions for urology.

A wide product range is available in different varieties and material qualities for transurethral interventions up to operations with DaVinci robots or other MIC methods.



Urology Drapes

TUR Drape with leggings and sieve 558882

Inliner: 8 drapes, PU: 16 drapes

Description	Size/cm	Qty.
TUR drape with 6 x 10 cm aperture, adhesive, with sieve, finger cot and Ø 6 cm suprapubic aperture with incision film	225 x 260	1

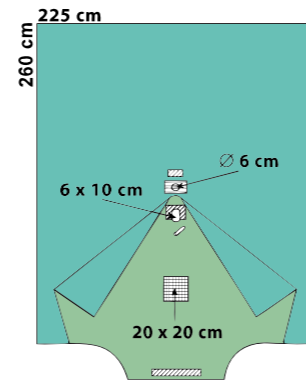

TUR Drape with leggings and fluid collection pouch 558892

Inliner: 6 drapes, PU: 12 drapes

Description	Size/cm	Qty.
TUR drape with 6 x 10 cm adhesive aperture; with fluid collection pouch with sieve, finger cot and drainage port; Ø 6 cm suprapubic aperture with incision film	225 x 260	1

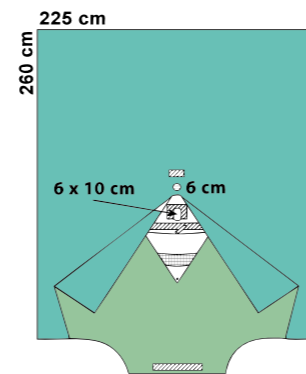

TUR Drape "small" with leggings and sieve 558862

Inliner: 15 drapes, PU: 30 drapes

Description	Size/cm	Qty.
TUR drape, 2-ply, with 6 x 10 cm aperture, adhesive, with sieve, finger cot and suprapubic aperture Ø 6 cm with incision film	150 x 200	1

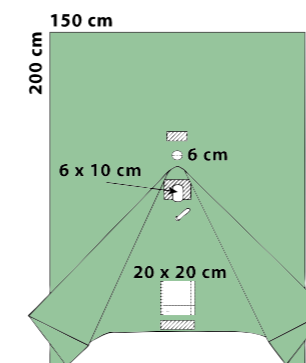

TUR Drape "small" with leggings and fluid collection pouch 559015-9

Description	Size/cm
TUR drape 2-ply, with Ø 6 cm non-adhesive aperture; with finger cot, large fluid collection pouch with sieve and drainage port, Ø 6 cm suprapubic aperture with incision film	150 x 200

Only available as a non-sterile pack component

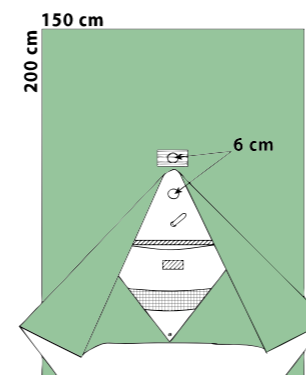

GYN-TVT Drape with leggings 559050-9

Description	Size/cm
GYN-TVT drape, 12/13 x 32 cm aperture, adhesive, with fluid collection pouches with sieve and drainage port	225 x 260

Only available as a non-sterile pack component

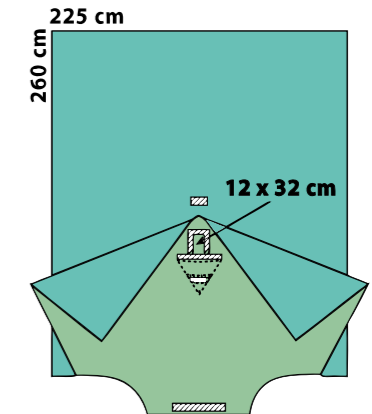

Universal Urology Drape 559086-9

Description	Size/cm
Urology drape 2-ply, with 6 x 10 cm aperture, adhesive, with finger cot, fluid collection sieve and drainage port, suprapubic aperture 15 x 13 cm with fenestrated incision film	150 x 200

Only available as a non-sterile pack component

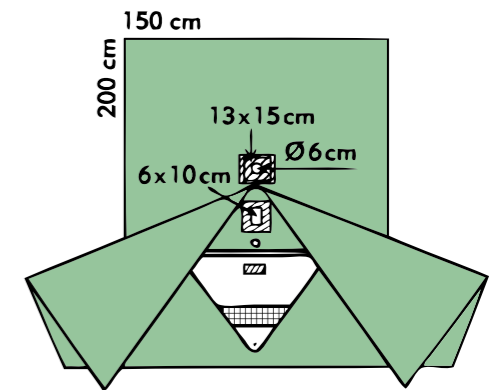

Urology Packs

TUR Pack, standard

561202

Inliner: 7 packs, PU: 14 packs

Cont. and sequence	Size/cm	Qty.	Ref. no.
Plain drape – table cover (wrap)	100 x 150	1	808823
Hand towels	20 x 25	4	-/-
TUR drape with 6 x 10 cm adhesive aperture; with sieve, finger cot and Ø 6 cm suprapubic aperture with incision film	225 x 260	1	558882

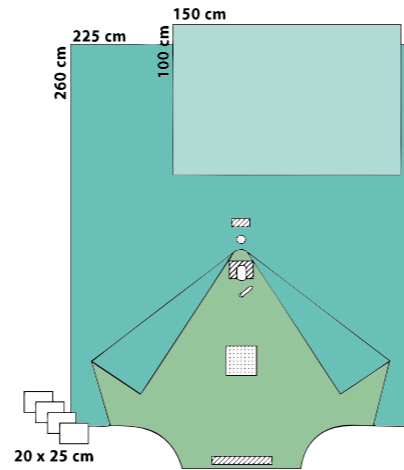

TUR Pack 2

564257

Inliner: 7 packs, PU: 14 packs

Cont. and sequence	Size/cm	Qty.	Ref. no.
Plain drape – table cover (wrap)	150 x 200	1	808869
Hand towels	20 x 25	2	-/-
OR tape	10 x 50	1	591050
TUR drape with 6 x 10 cm adhesive aperture; with sieve and finger cot	225 x 260	1	559011

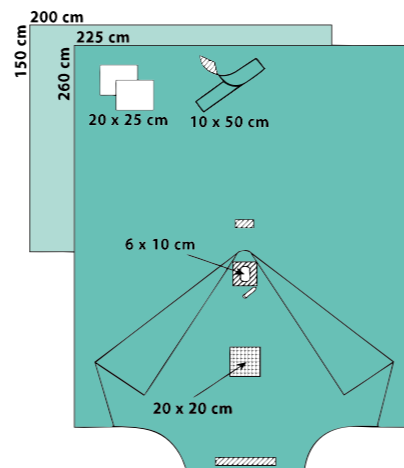

Particularity: with larger back table cover, TUR drape without suprapubic aperture

Split Sheets/DaVinci Drape

Split Sheet with leggings

528876-9

Description	Size/cm
-------------	---------

Split sheet with U-slit 45 x 90 cm, adhesive with leggings

225 x 240

Only available as a non-sterile pack component

In combination with an adhesive drape it is possible to create a variable incision area

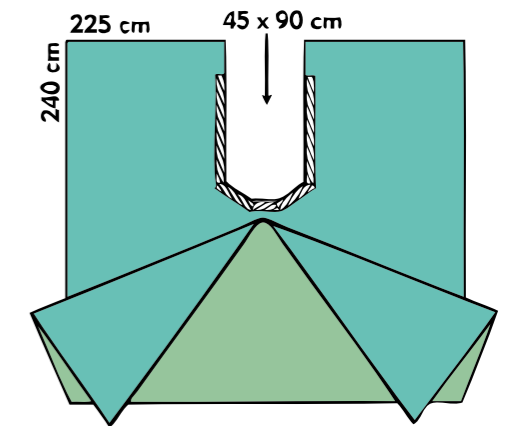

Split Sheet with rectal aperture and leggings

528877-9

Description	Size/cm
-------------	---------

Split sheet with U-slit 45 x 90 cm, adhesive with leggings and rectal aperture 14 x 16 cm

225 x 240

Only available as a non-sterile pack component

In combination with an adhesive drape it is possible to create a variable incision area

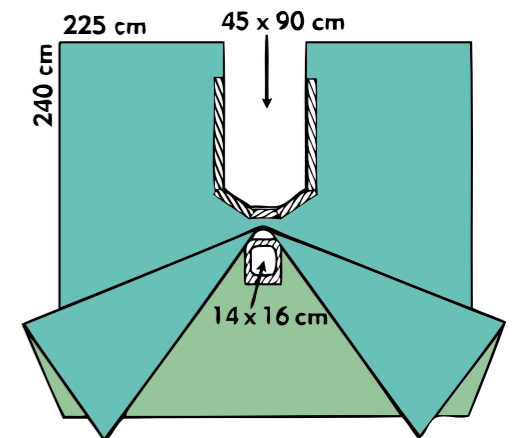

DaVinci Drape, T-Form

558874-9

Description	Size/cm
-------------	---------

T-form, OR aperture 45 x 50 cm, adhesive, with leggings, MIS diathermy pouch 50 x 30 cm, diathermy pouch 60 x 27 cm and 2 velcro strips

300/225 x 495

Only available as a non-sterile pack component

For procedures with DaVinci robot or other MIS methods.

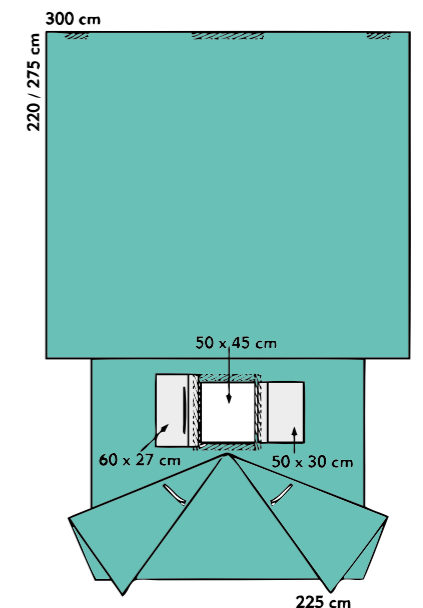

Small Drapes and Packs

TUR Drape 518841

Dispenser, PU: 60 drapes

Description	Size/cm	Qty./disp.
TUR drape, 2-ply, \diamond 8 x 11 cm non-adhesive aperture, decentral; with sieve	100 x 230	15

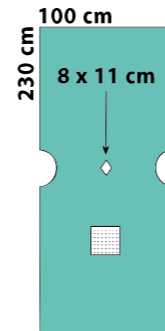

CYST Drape 518842

Dispenser, PU: 88 drapes

Description	Size/cm	Qty./disp.
CYST drape, 2-ply, \diamond 8 x 11 cm non-adhesive aperture, central	75 x 200	22

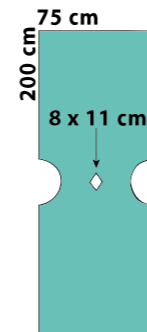

CYST Pack 561204

Inliner/PU: 20 packs

Cont. and sequence	Size/cm	Qty.	Ref. no.
Plain drape, 2-ply	75 x 90	1	508824
CYST drape, 2-ply, \diamond 8 x 11 cm aperture	75 x 200	1	518842
Leggings, 2-ply	75 x 120	2	588812

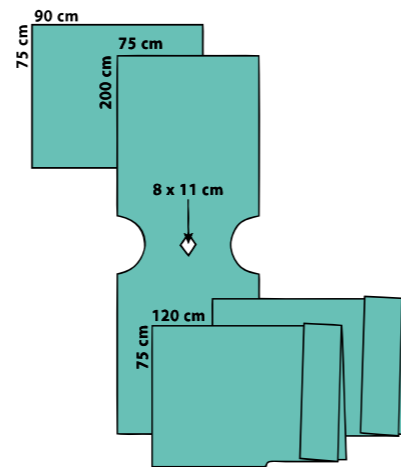

CYST Pack, aquamarine 861204

Inliner/PU: 20 packs

Cont. and sequence	Size/cm	Qty.	Ref. no.
Plain drape, 2-ply	75 x 90	1	808824
CYST drape, 2-ply, \diamond 8 x 11 cm aperture	75 x 200	1	818842
Leggings, 2-ply	75 x 120	2	888812

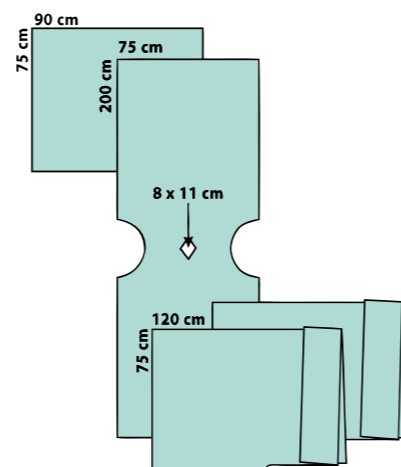

Supplementary Products

Rectal Shield 516601

Dispenser, PU: 228 drapes

Description	Size/cm	Qty./disp.
Rectal shield with finger cot and adhesive zones	60 x 90	38

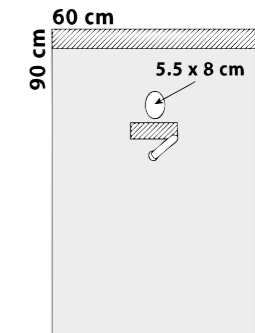

TUR Gown

Description	Length/cm	Qty.	Ref. no.
Non-woven yoke area Inliner: 15 gowns, PU: 30 gowns	L/XL = 140	1	464455
Non-woven yoke area Inliner: 15 gowns, PU: 30 gowns	XL = 150	1	464428



Leggings dispenser

Description	Length/cm	Qty./disp.	Ref. no.
Mediwell super 2-ply PU: 60 pairs	50 x 110	10 pairs	538811
Mediwell super 2-ply PU: 48 pairs	75 x 120	12 pairs	588812
aquamarine 2-ply PU: 48 pairs	75 x 120	12 pairs	888812

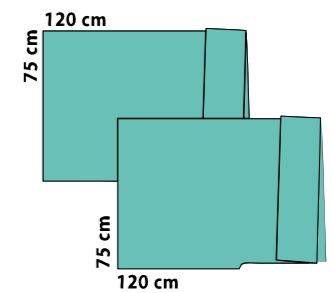

Fluid Collection Pouch, adhesive 589901

Dispenser, PU 50 pouches

Description	Length/cm	Qty./disp.
with sieve and drainage port	55 x 50	25

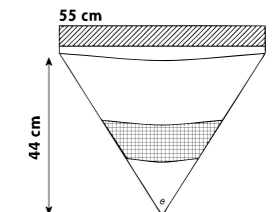

Split Aperture Drape 520057-9

Description	Length/cm
Split aperture drape Mediwell 2-ply aperture \varnothing 6 cm, central, slit 27 cm	60 x 60

Only available as a non-sterile pack component

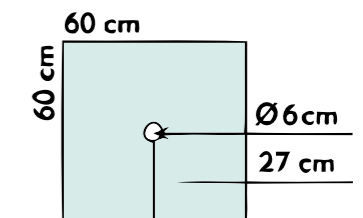

Gynaecology

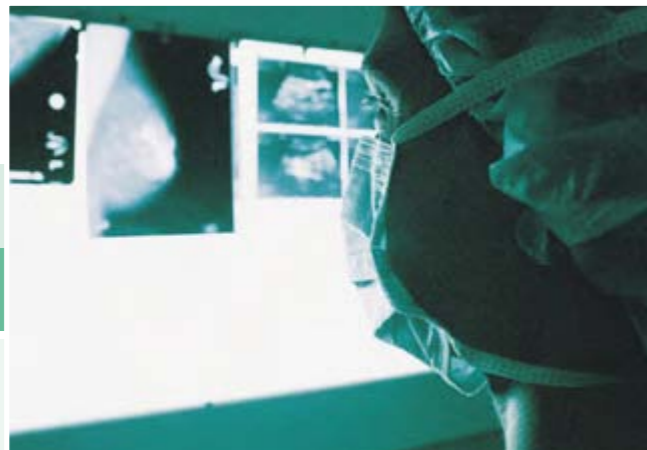

For the special requirements in gynaecology our product range includes a selection of drapes and packs for vaginal and abdominal interventions. Our C-section drapes are especially adapted to the anatomy of expectant mothers and are suitable for various positions.

Different drape variations are available for outpatient interventions, as well as for laparoscopically assisted vaginal hysterectomies.



GYN Drape and Pack

GYN/TVT Drape with leggings 559050-9

Description	Size/cm
GYN/TVT drape, 12/13 x 32 cm aperture, adhesive, with fluid collection pouch with sieve and drainage port	225 x 260
Only available as a non-sterile pack component	

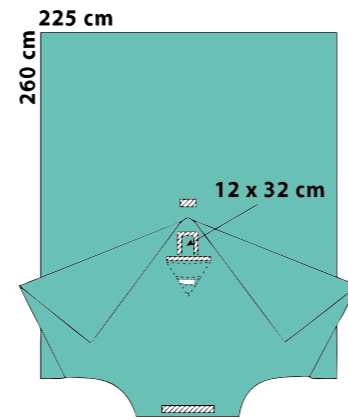

GYN Pack, standard 561207

Inliner: 6 packs, PU: 12 packs

Cont. and sequence	Size/cm	Qty.	Ref. no.
Plain drape – table cover (wrap)	150 x 180	1	808821
Mayo stand cover	80 x 145	1	547714
Hand towels	20 x 25	4	-/-
Adhesive drape, 2-ply	50 x 50	1	538822
GYN drape with leggings, 9 x 17 cm aperture, adhesive	225 x 260	1	558881

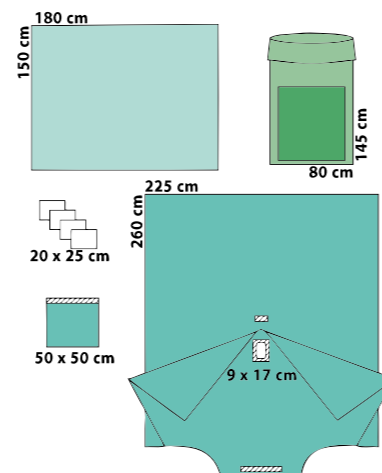

Pfannenstiel Drape and Pack

Pfannenstiel Drape 558807

Inliner: 7 drapes, PU: 14 drapes

Description	Size/cm	Qty.
Pfannenstiel drape, 18 x 29 cm aperture, adhesive	225 x 320	1

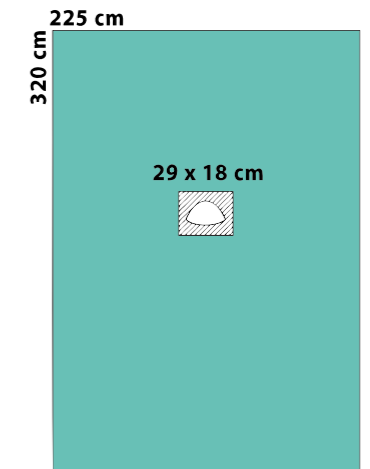

Pfannenstiel Pack, standard 561208

Inliner: 4 packs, PU: 8 packs

Cont. and sequence	Size/cm	Qty.	Ref. no.
Plain drape – table cover (wrap)	150 x 180	1	808821
Mayo stand cover	80 x 145	1	547714
Hand towels	20 x 25	4	-/-
OR tape	10 x 50	1	591050
Pfannenstiel drape with leggings, 18 x 29 cm aperture, adhesive	225 x 320	1	558883

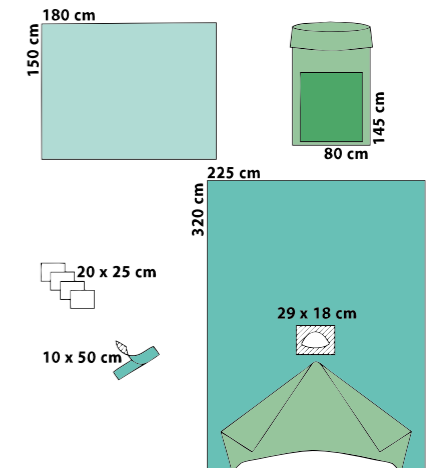

C-Section Drapes and Pack

C-Section Drape 558813

Inliner: 6 drapes, PU: 12 drapes

Description	Size/cm	Qty.
C-section drape with adhesive 29 x 24 cm aperture; with 360° fluid collection pouch with aperture incision film and drainage port	225 x 320	1

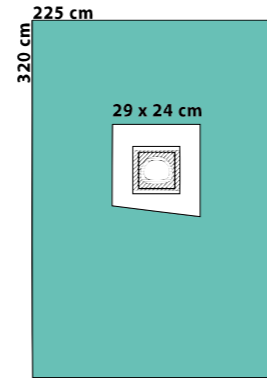

C-Section Drape T-Form aquamarine 859122-9

Description	Size/cm
T-form, adhesive 37 x 37 cm aperture; with 360° fluid collection pouch with 17.5 x 21 cm aperture incision film and integral cable/tube holder	280/225 x 300

Only available as a non-sterile pack component

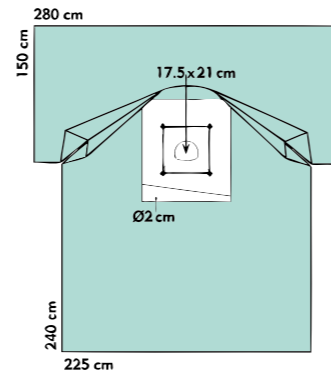

C-Section Pack, standard 561206

Inliner: 3 + 4 packs, PU: 7 packs

Cont. and sequence	Size/cm	Qty.	Ref. no.
Plain drape – table cover (wrap)	150 x 180	1	808821
Mayo stand cover	80 x 145	1	547714
Hand towels	20 x 25	4	-/-
Sectio drape with leggings, with 24 x 29 cm aperture, adhesive, with 360° fluid collection pouch with aperture incision film and drainage port	225 x 320	1	558893
Baby sheet, 2-ply	100 x 150	1	508823

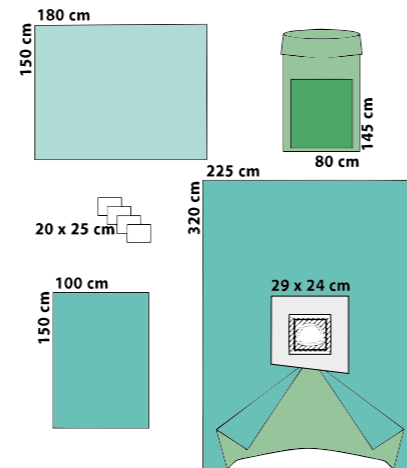

C-Section Drape with leggings 558893

Inliner: 5 + 5 drapes, PU: 10 drapes

Description	Size/cm	Qty.
C-section drape with leggings, 29 x 24 cm aperture, adhesive; with 360° fluid collection pouch with aperture incision film and drainage port	225 x 320	1

C-Section Drape T-Form 559057-9

Description	Size/cm
C-section drape in T-form, anaesthesia part with double film thickness, 3 integral adhesive strips to fix; aperture 29 x 30 cm, fluid collection pouch with aperture incision film and drainage port	280/225 x 390

Only available as a non-sterile pack component

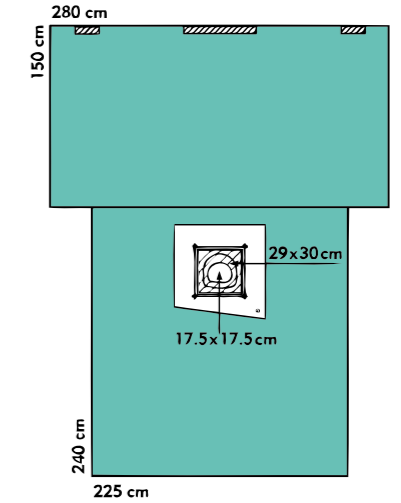

C-Section Drape 558942-9

Description	Size/cm
C-section drape with adhesive 29 x 24 cm aperture, with 360° fluid collection pouch incision film and drainage port	225 x 320

Only available as a non-sterile pack component

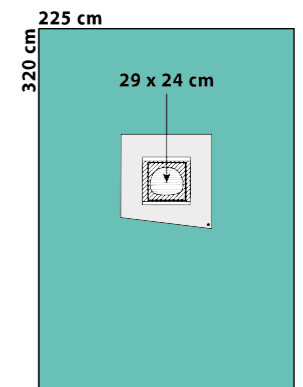

Baby Sheet Mediwell soft 585764

Dispenser, PU: 120 drapes

Description	Size/cm	Qty./disp.
Plain drape	100 x 150	30

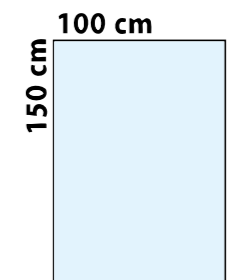

GYN/LAP Drapes

GYN/LAP Drape 558887

PU: 5 drapes

Description	Size/cm	Qty.
GYN/LAP drape with 29 x 32 cm adhesive aperture; with additional 9 x 17 cm vaginal aperture, adhesive, with protective curtain	225 x 320	5

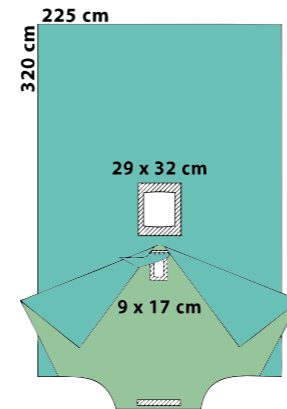

GYN/LAP Drape T-Form 559062-9

Description	Size/cm
GYN/LAP-drape T-form, anaesthesia part with double film thickness, 3 integral adhesive strips to fix; aperture 29 x 32 cm, adhesive, with additional vaginal aperture 9 x 17 cm, adhesive, with protective curtain	280/225x350

Only available as a non-sterile pack component

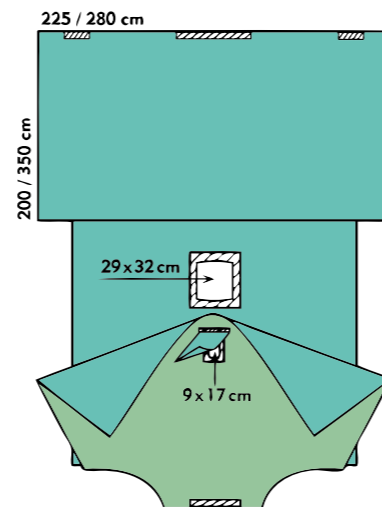

Small Drapes

CYST Drape 518842

Dispenser, PU: 88 drapes

Description	Size/cm	Qty./disp.
CYST drape, 2-ply, \diamond 8 x 11 cm aperture, central	75 x 200	22

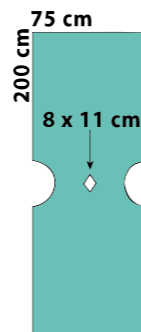

Under Buttocks Drape 508887

Dispenser, PU: 120 drapes

Description	Size/cm	Qty./disp.
Under buttocks drape, 2-ply with 20 cm turn-up	75 x 100	30

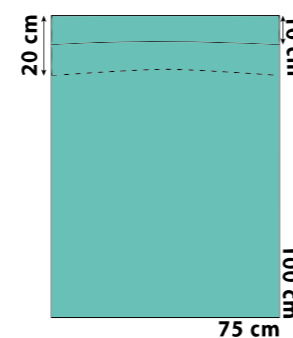

Small Drapes

Under Buttocks Drape 506667

Dispenser, PU: 60 drapes

Description	Size/cm	Qty./disp.
Under buttocks drape, Colordrape, with 20 cm turn-up, 54 x 43 cm non-woven reinforcement and fluid collection pouch with scale, sieve and drainage port	100 x 120	15

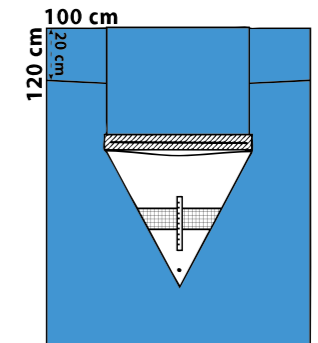

Leggings dispenser

Description	Size/cm	Qty./disp.	Ref. no.
Mediwell super, 2-ply PU: 60 pairs	50 x 100	10 pairs	588811
Mediwell super, 2-ply PU: 48 pairs	75 x 125	12 pairs	588812
aquamarine, 2-ply PU: 48 pairs	75 x 120	12 pairs	888812

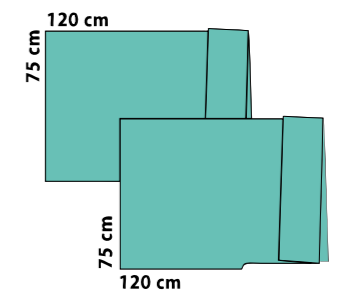

CYST Pack 561204

Inliner/PU: 20 packs

Cont. and sequence	Size/cm	Qty.	Ref. no.
Plain drape, 2-ply	75 x 90	1	508824
CYST drape, 2-ply, \diamond 8 x 11 cm aperture, central	75 x 200	1	518842
Leggings, 2-ply	75 x 120	2	588812

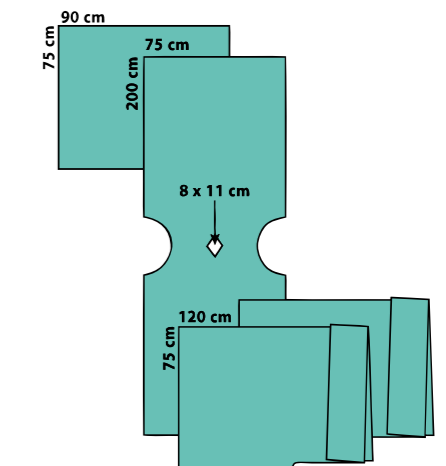

CYST Pack, aquamarine 861204

Inliner/PU: 20 packs

Cont. and sequence	Size/cm	Qty.	Ref. no.
Plain drape, 2-ply	75 x 90	1	808824
CYST drape, 2-ply, \diamond 8 x 11 cm aperture	75 x 200	1	818842
Leggings, 2-ply	75 x 120	2	888812

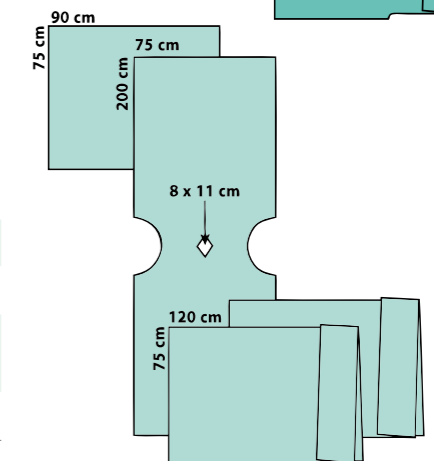

Neurosurgery, ENT, OMS, Ophthalmology



The innovative neurosurgery drapes have a reinforced incision area and generous fluid collection pouch allows an effective fluid management.

The turban drape can be flexibly used in face surgery. Special eye and ENT drapes offer a user-friendly solution.

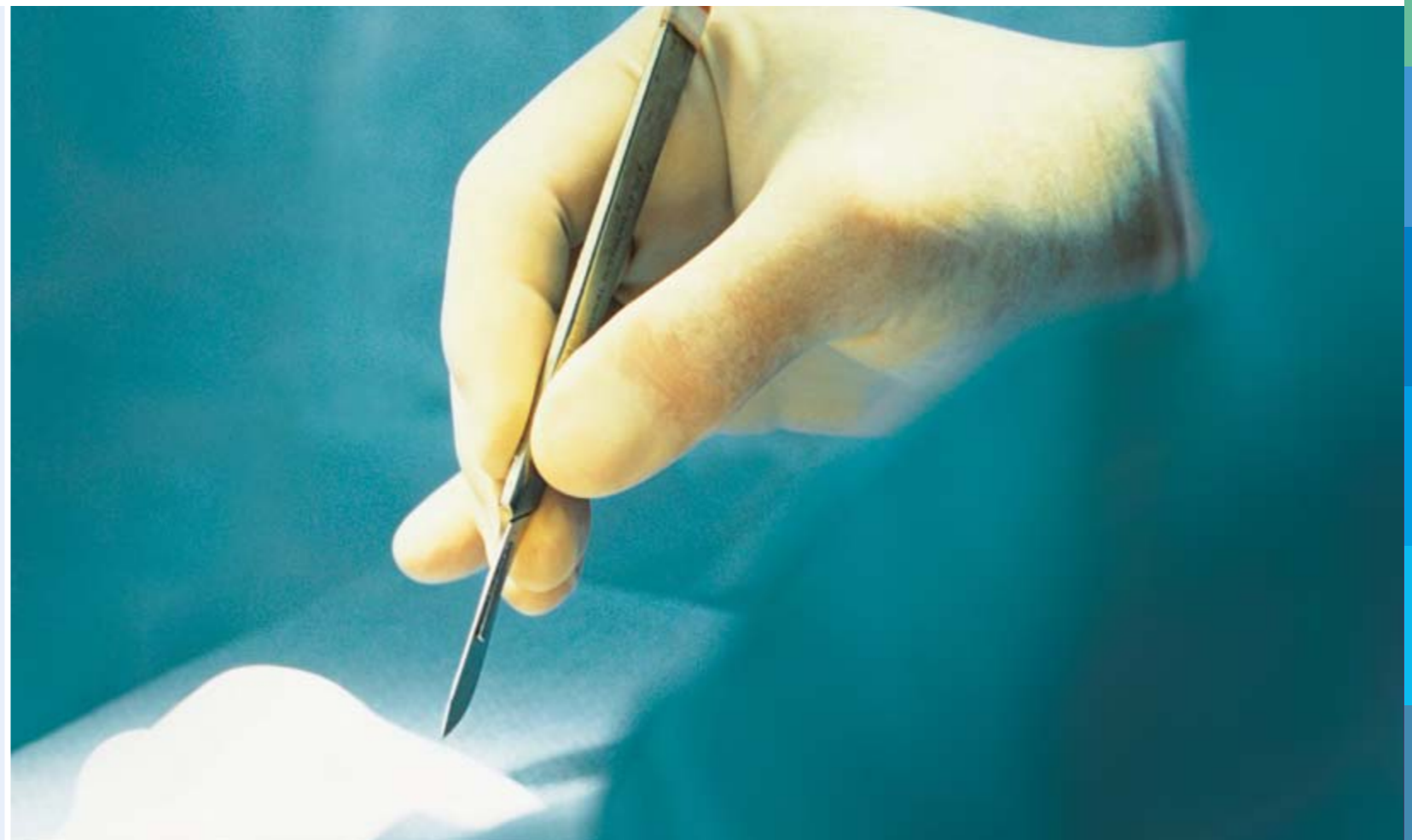

Neurosurgery Drapes

Neurosurgery Drape, standard 558845

PU: 14 drapes

Description	Size/cm	Qty.
Neurosurgery drape, 2-ply, with 25 x 20.5 cm aperture, with integral 48 x 80 cm incision film, partially as a reinforcement with fluid collection pouch with sieve and drainage port	300 x 225	7

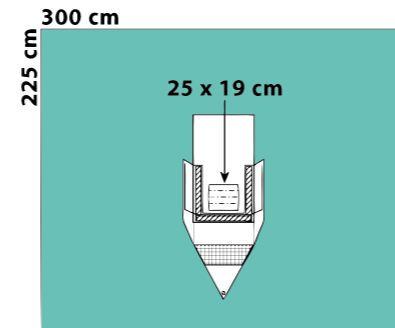

Neurosurgery Drape, aquamarine 859140-9

Description	Size/cm
Neurosurgery drape, aquamarine 3-ply, with anti-slipping reinforcement, 30 x 19 cm aperture, with integral 50 x 80 cm incision film, partially as a reinforcement, 9 velcro strips. Separate: fluid collection pouch with sieve and drainage port	340 x 225

Only available as a non-sterile pack component

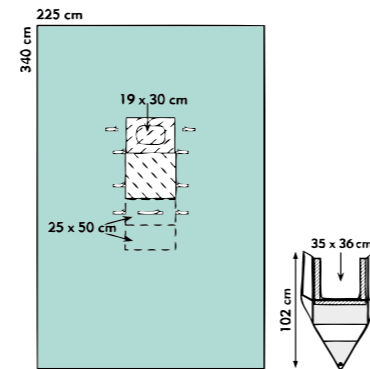

Laminectomy Drapes

Laminectomy Drape 558808

PU: 12 drapes

Description	Size/cm	Qty.
Laminectomy drape, 10.5 x 25 cm aperture, decentral, adhesive	225 x 320	6

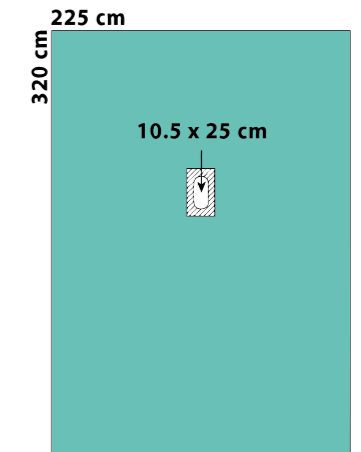

Laminectomy Drape T-Form 559085-9

Description	Size/cm
Laminectomy drape, T-form, aperture 10 x 15 cm, decentral, adhesive	280/225 x 340

Only available as a non-sterile pack component

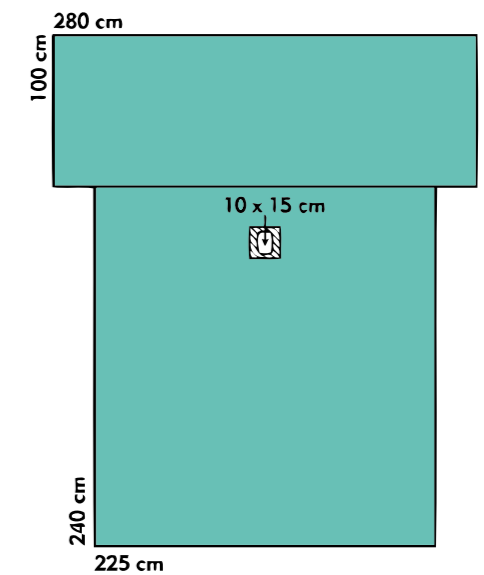

Turban Drape

Turban Drape 538919

Dispenser, PU: 50 drapes

Description	Size/cm	Qty./disp.
Turban drape, 3-ply, 2-part, with adhesive areas	100/90 x 75	50

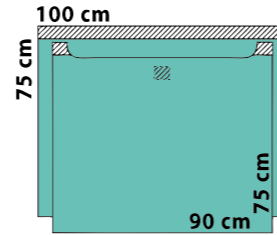

ENT Drapes

Ear Drape 558958-9

Description	Size/cm	Qty.	Ref. no.
Ear drape, with 7 x 10 cm aperture, adhesive and integral Mediwell absorb reinforcement	150 x 160	1	558958
Included loose fluid collection pouches with sieve and drainage port	55 x 50	1	589901

Only available as a non-sterile pack component

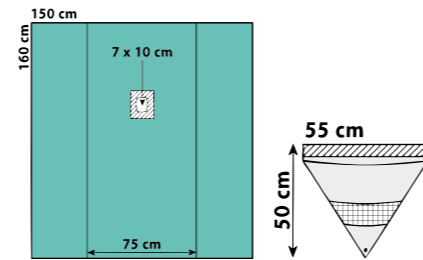

Paediatrics/ENT Split Sheet 528815

PU: 14 drapes

Description	Size/cm	Qty.
Split sheet with 7.5 x 65 cm U-slit and special adhesive for sensitive skin	200 x 260	7

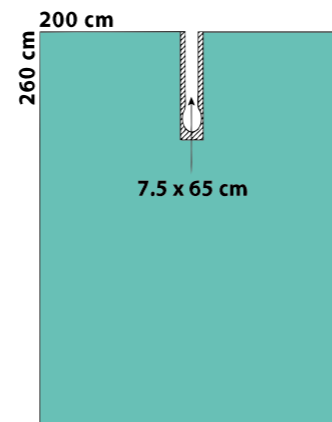

OR Tape 592025

Dispenser, PU: 420 tapes

Description	Size/cm	Qty./disp.
Non-woven, standard, adhesive layer impermeable to fluids	20 x 25	70

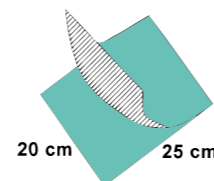

Eye Drapes

Eye Drape 585701

Dispenser, PU: 80 drapes

Description	Size/cm	Qty./disp.
Eye drape, Mediwell soft, with 10 x 7 cm aperture with integral incision film and fluid collection pouch with pliable metal strip	120 x 150	20

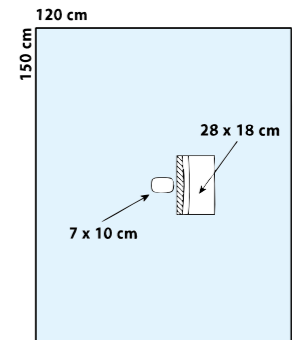

Eye Drape 585703

Dispenser, PU: 40 drapes

Description	Size/cm	Qty./disp.
Eye drape, Mediwell soft, with 10 x 7 cm aperture with dual fluid collection pouch with pliable metal strips and integral incision film	150 x 240	10

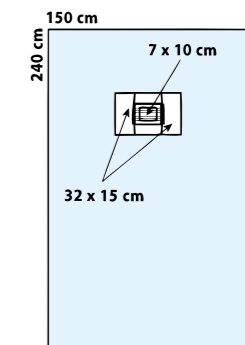

Eye Drape 585731

Dispenser, PU: 70 drapes

Description	Size/cm	Qty./disp.
Eye drape, Mediwell light, with 10 x 7 cm aperture, central, with integral incision film and fluid collection pouch with pliable metal strip	120 x 150	35

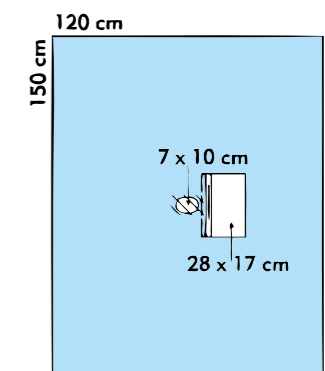

Eye Drape 555751

Dispenser, PU: 24 drapes

Description	Size/cm	Qty./disp.
Eye drape, Mediwell light, with 12 x 10 cm aperture, with dual fluid collection pouch with pliable metal strips and 2 nose strips	160 x 255	12

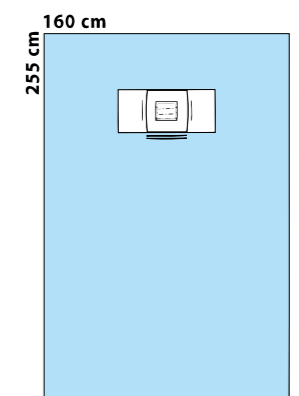

Ophthalmological Drapes

Aperture Drape, Filmdrape **556601**

Dispenser, PU: 840 drapes

Description	Size/cm	Qty./disp.
Ø 6 cm aperture, adhesive	40 x 40	140

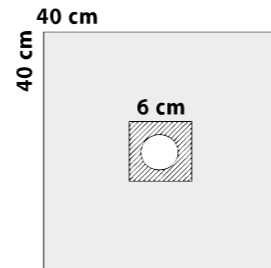

Aperture Drape, Filmdrape **556602**

Dispenser, PU: 480 drapes

Description	Size/cm	Qty./disp.
Ø 6 cm aperture, adhesive	57 x 65	80

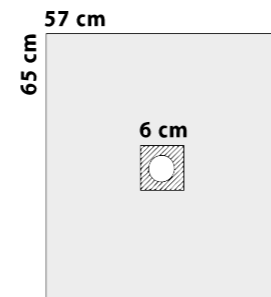

Eye Drape, Filmdrape **556652**

Dispenser, PU: 200 drapes

Description	Size/cm	Qty./disp.
Ø 6 cm aperture, adhesive, with fluid collection pouch with pliable metal strip	57 x 65	50

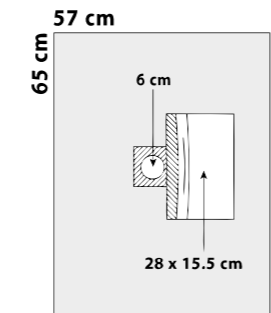

Eye Drape, Filmdrape **586601**

Dispenser, PU: 160 drapes

Description	Size/cm	Qty./disp.
Aperture 7.5 x 5 cm, adhesive, with fluid collection pouch with pliable metal strip	100 x 105	40

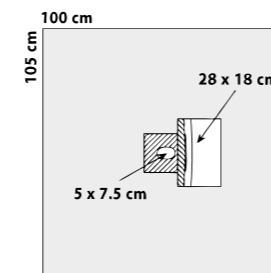

Supplementary Products

Armrest Covers dispenser

Mediwell super, 2-ply

Description	Size/cm	Qty./disp.	Ref. no.
with integral tape strip PU: 90 pairs	35 x 73	15 pairs	583573
elastified PU: 80 pairs	25 x 70	20 pairs	583574

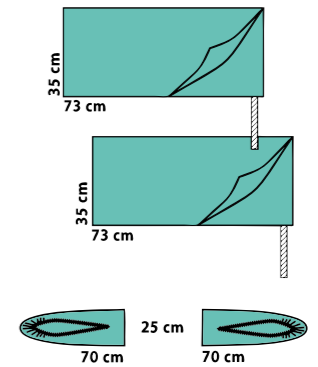

Stool Cover dispenser

Description	Size/cm	Qty./disp.	Ref. no.
Mediwell super, 2-ply PU: 90 covers	75 x 75	15	588875
Mediwell super, 2-ply elastified PU: 210 covers	60 x 60	35	588860

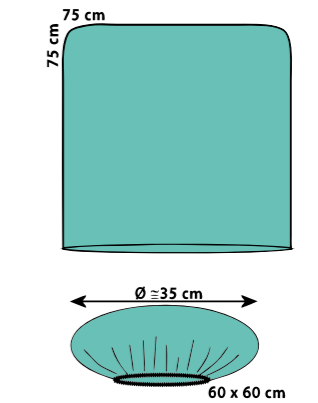

Special Tie Gowns/SP for ophthalmology

Description	Length/cm	Ref. no.
	L=130	464423-9
	L/XL=140	464462-9
	XL=150	464426-9

Only available as a non-sterile pack component

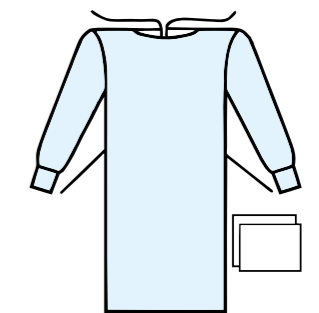

Accessories dispenser

Description	Size/cm	Qty./disp.	Ref. no.
Velcro strip PU: 600 pcs.	2/2.5 x 24	100	592525
Incision film PU: 900 pcs.	10 x 18	150	591018

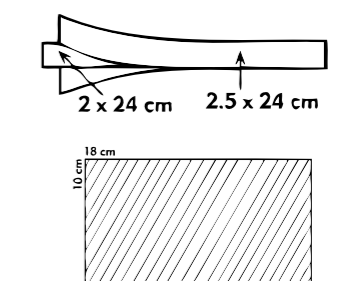

Paediatrics



The child as a patient: Our product range includes a paediatric line with very skin-friendly adhesive tapes for the high quality demands of paediatric surgery.

Special extremity and aperture drapes are adapted to the proportions of infants and babies. Furthermore, we offer paediatric universal packs to ensure the best possible care of small patients.



Paediatric Drapes and Pack

Adhesive Drapes

Mediwell super strong

Dispenser, PU: 160 drapes

Description	Size/cm	Qty./disp.	Ref. no.
with special adhesive 2.5 x 100 cm	75 x 100	40	538914

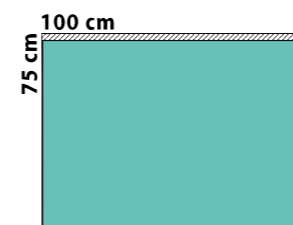

Paediatrics Aperture Drapes, adhesive

Mediwell super or Mediwell super strong

Description	Size/cm	Qty.	Ref. no.
7 x 10 cm aperture, 2-ply Dispenser, PU: 100 drapes	100 x 150	25	558974
16 x 12 cm aperture Inliner, PU: 14 drapes	200 x 280	7	558809

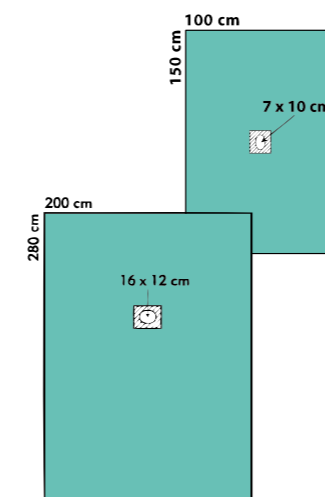

Universal Pack, paediatrics

561007

Inliner: 3 + 4, PU: 7 packs

Cont. and sequence	Size/cm	Qty.	Ref. no.
Plain drape – table cover (wrap)	150 x 180	1	808821
Mayo stand cover	80 x 145	1	547714
Hand towels	25 x 20	4	-/-
OR tape, elastic	10 x 50	1	591151
Side drape	75 x 100	2	538914
Foot drape	175 x 180	1	538916
Head drape	150 x 240	1	538917

Particularity: with special adhesive for sensitive skin and 2.5 cm wide adhesive zones.

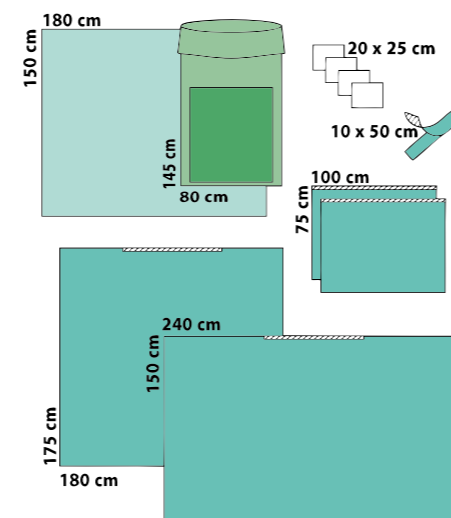

Extremity Drape

518815

Mediwell super strong

Inliner: 6 drapes, PU: 12 drapes

Description	Size/cm	Qty.
Hand/foot extremity drape, with Ø 3 cm elastic aperture, decentral, for hand/foot or child extremities	225 x 300	1

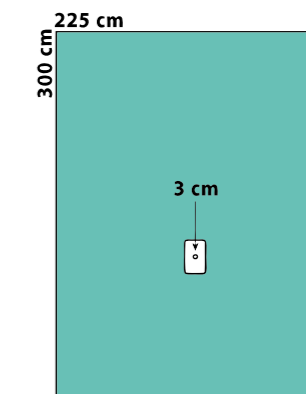

Split Sheet, paediatrics

528815

Mediwell super strong

Inliner: 7 drapes, PU: 14 drapes

Description	Size/cm	Qty.
U=7.5 x 65 cm, adhesive	200 x 260	1

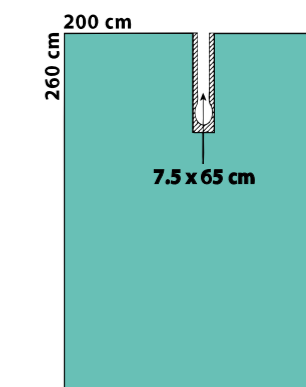

Accessories dispenser

Description	Size/cm	Qty./disp.	Ref. no.
Child stockinette, 2-ply with OR tape PU: 120 pcs.	17 x 75	30	588827
OR tape, elastic PU: 750 pcs.	10 x 50	125	591151

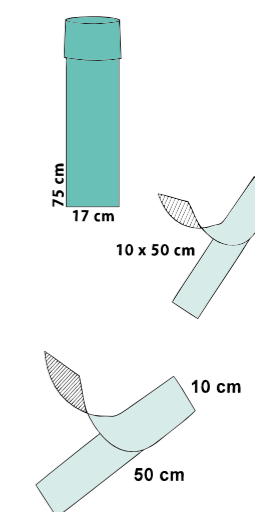

Day Surgery



Full flexibility combined with highest quality standards: To fulfil the special requirements of day surgeries, we have a wide range of products including various packs and drapes, OR tape and mayo stand covers. This applies not only to general surgery: You can also count on our indication-related and user-friendly solutions in the fields of orthopaedic and traumatologic surgery as well as in gynaecology and urology.



General Surgery

Universal Pack, standard

561088

Inliner: 3 + 4 packs, PU: 7 packs

Cont. and sequence	Size/cm	Qty.	Ref. no.
Plain drape – table cover (wrap)	150 x 180	1	808821
Mayo stand cover	80 x 145	1	547714
Hand towels	25 x 20	4	-/-
OR tape	10 x 50	1	591050
Side drapes	75 x 100	2	538811
Foot drape	175 x 180	1	538806
Head drape	150 x 240	1	538807

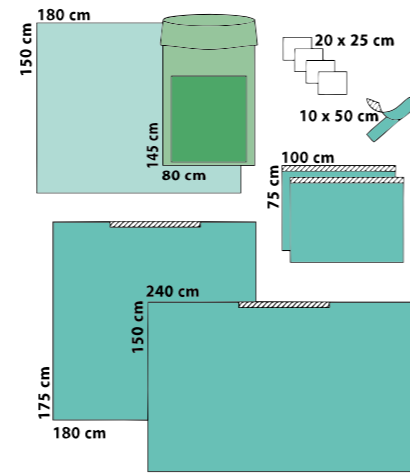

Split Sheet Pack, aquamarine

861112

Inliner: 3 + 4 packs, PU: 7 packs

Cont. and sequence	Size/cm	Qty.	Ref. no.
Plain drape – table cover (wrap)	150 x 180	1	808821
Mayo stand cover	80 x 145	1	547714
Hand towels	25 x 20	2	-/-
Plain drape, 2-ply, as bottom drape	150 x 180	1	808821
Split sheet, U=7.5 x 100 cm	200 x 260	1	828805
Adhesive drape	150 x 240	1	838807

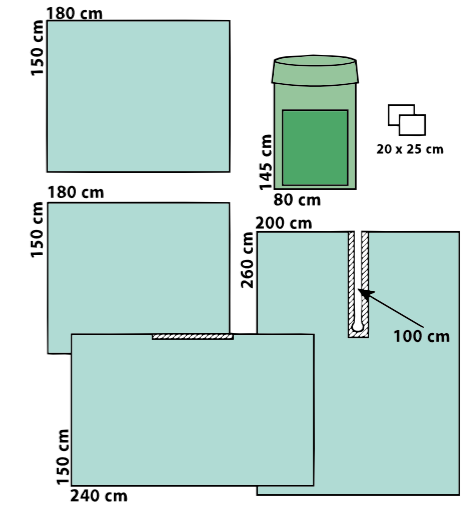

Universal Pack, aquamarine

861088

Inliner: 4 packs, PU: 8 packs

Cont. and sequence	Size/cm	Qty.	Ref. no.
Plain drape – table cover (wrap)	150 x 180	1	808821
OR tape	10 x 50	1	591050
Hand towels	25 x 20	2	-/-
Mayo stand cover	80 x 145	1	547714
Side drapes, 2-ply	75 x 90	2	838823
Foot drape	180 x 175	1	838806
Head drape	150 x 240	1	838807

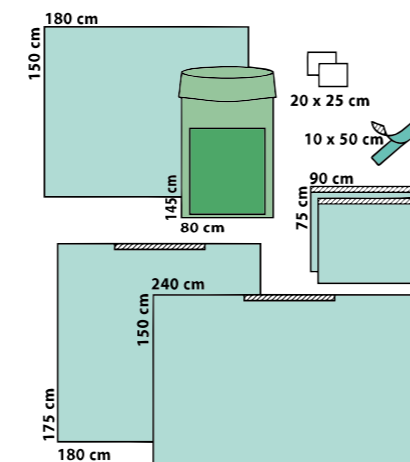

Split Sheet Pack, standard

561112

Inliner: 3 + 4 packs, PU: 7 packs

Cont. and sequence	Size/cm	Qty.	Ref. no.
Plain drape – table cover (wrap)	150 x 180	1	808821
Mayo stand cover	80 x 145	1	547714
Hand towels	25 x 20	4	-/-
Bottom drape, Mediwell, 3-ply	150 x 180	1	501518
Split sheet, U=7.5 x 100 cm	200 x 260	1	528805
Adhesive drape	150 x 240	1	538807

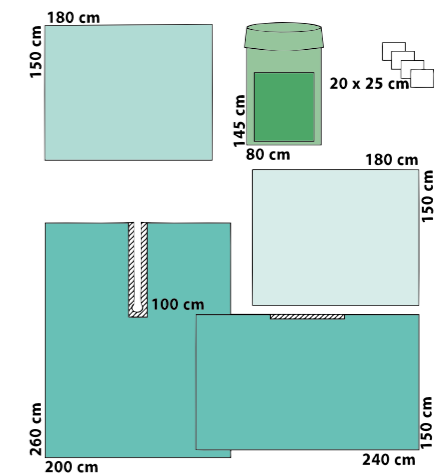

Traumatology and Orthopaedic Surgery

Arthroscopy Pack, standard 1 561105

Inliner: 5 packs, PU: 10 packs

Cont. and sequence	Size/cm	Qty.	Ref. no.
Medinop overwrap	85 x 100	1	628510
Mayo stand cover	80 x 145	1	547714
Hand towels	20 x 25	4	-/-
Stockinette, 2-ply	33 x 73	1	583355
OR tape, film	11 x 50	2	591150
Extremity drape with Ø 7 cm elastic aperture with cable/ tube holder	225 x 325	1	518810

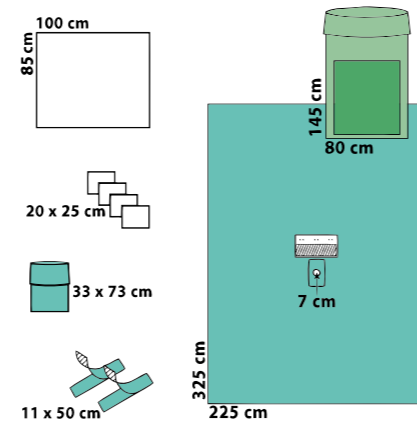

Arthroscopy Pack, standard 3 563035

Inliner: 3 packs, PU: 6 packs

Cont. and sequence	Size/cm	Qty.	Ref. no.
Medinop overwrap	85 x 100	1	628510
Hand towels	30 x 40	2	-/-
OR gown, standard	XL = 150	1	464416
OR gown, reinforced	XL = 150	1	464417
Mayo stand cover	80 x 145	1	547714
Stockinette, 2-ply	33 x 73	1	583355
OR tape, film	11 x 50	2	591150
Camera tube cover, telescopically	13 x 250	1	581323
Extremity drape, 2-ply, with Ø 7 cm elastic aperture, decentral and integral velcro strip	200 x 300	1	518819

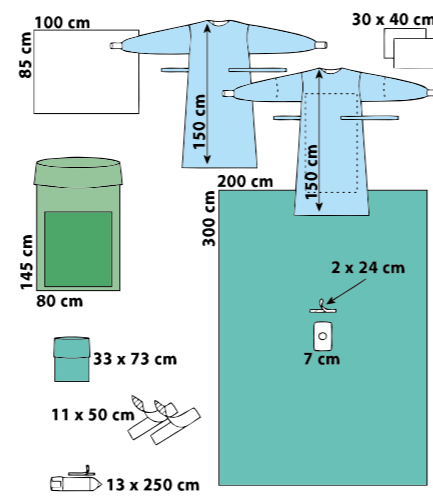

Arthroscopy Pack, aquamarine 861122

Inliner: 5 packs, PU: 10 packs

Cont. and sequence	Size/cm	Qty.	Ref. no.
Plain drape – table cover (wrap)	150 x 180	1	808821
Mayo stand cover	80 x 145	1	547714
Stockinette, 2-ply	33 x 73	1	883355
OR tape, film	11 x 50	2	591150
Camera tube cover, telescopically	13 x 250	1	581323
Velcro strip	2/2.5 x 24	1	592525
Extremity drape, with Ø 7 cm elastic aperture	200 x 300	1	818820

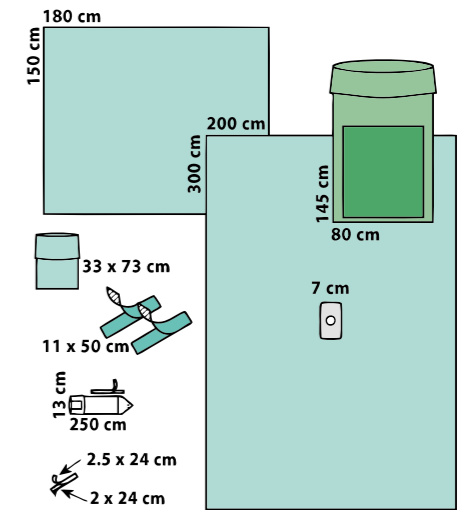

Arthroscopy Drape, "small" 518853

Inliner: 12 drapes PU: 24 drapes

Description	Size/cm	Qty.
Arthroscopy drape "small", 2-ply, with cable/tube holder and fluid collection pouch with drainage port	200 x 300	1

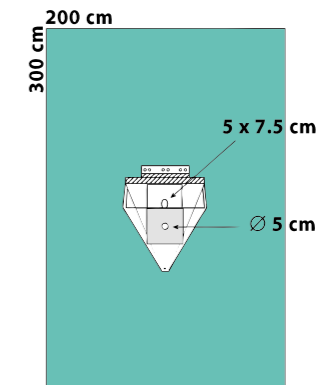

Hand Surgery Drape 518844

PU: 20 drapes

Description	Size/cm	Qty.
Hand Surgery drape, 2-ply, T-form, with integral arm table cover and elastic aperture Ø 3 cm	360/150 x 330	10

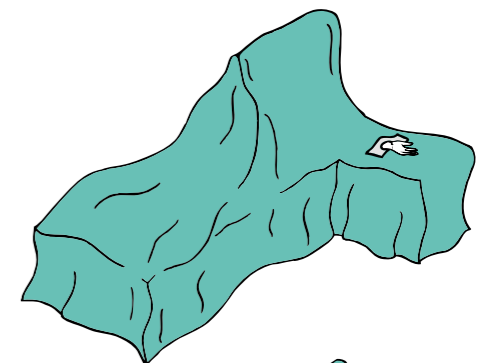

Hand Surgery Drape 518845

PU: 20 drapes

Description	Size/cm	Qty.
Hand surgery drape, 2-ply, T-form, with integral arm table cover and elastic aperture Ø 3 cm	360/160 x 280	10

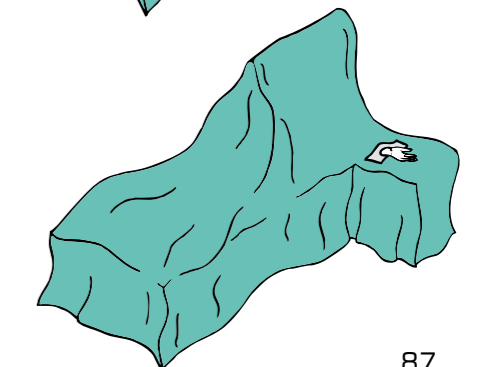

Traumatology and Orthopaedic Surgery

Hand/Foot Pack

564185

Inliner: 5 packs, PU: 10 packs

Cont. and sequence	Size/cm	Qty.	Ref. no.
Plain drape – table cover (wrap)	150 x 200	1	808869
Mayo stand cover	80 x 145	1	547714
Hand/Foot drape	225 x 300	1	518815

Particularity: with larger back table cover

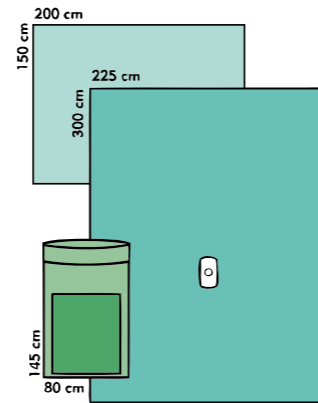

Hand/Foot Pack, aquamarine

818815-9

Description	Size/cm
Extremity drape, 2-ply with Ø 3 cm elastic aperture	225 x 300

Only available as a non-sterile pack component

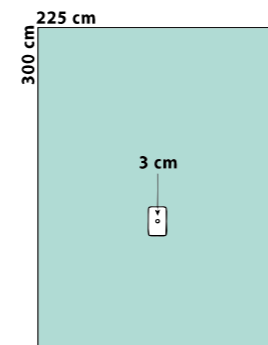

Extremity Drape "small"

518827

Dispenser, PU: 40 drapes

Description	Size/cm	Qty./disp.
Extremity drape, 2-ply with Ø 4 cm elastic aperture	150 x 200	20

For procedures on the distal extremities

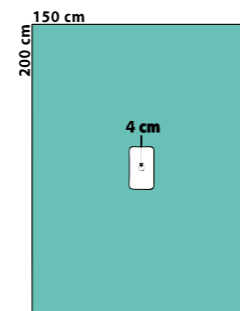

Extremity Drape

518820

Inliner: 8 drapes, PU: 16 drapes

Description	Size/cm	Qty.
Extremity drape, 2-ply with Ø 7 cm elastic aperture	200 x 300	1

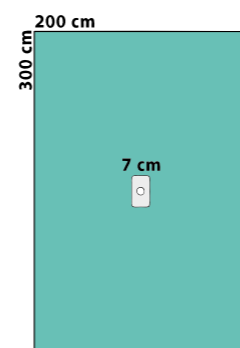

Gynaecology/Urology

TUR Pack, standard

561202

Inliner: 7 packs, PU: 14 packs

Cont. and sequence	Size/cm	Qty.	Ref. no.
Plain drape – table cover (wrap)	100 x 150	1	808823
Hand towels	20 x 25	4	-/-
TUR drape with 6 x 10 cm adhesive aperture; with sieve, finger cot and Ø 6 cm supra-pubic aperture with incision film	225 x 260	1	558882

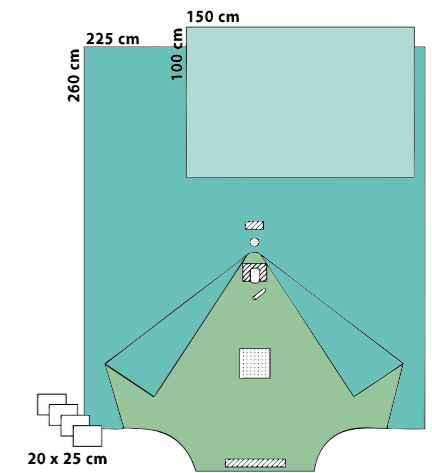

CYST Pack, aquamarine

861204

Inliner/PU: 20 packs

Cont. and sequence	Size/cm	Qty.	Ref. no.
Plain drape, 2-ply	75 x 90	1	808824
CYST drape, 2-ply, ◇ 8 x 11 cm aperture	75 x 200	1	818842
Leggings, 2-ply	75 x 125	2	888812

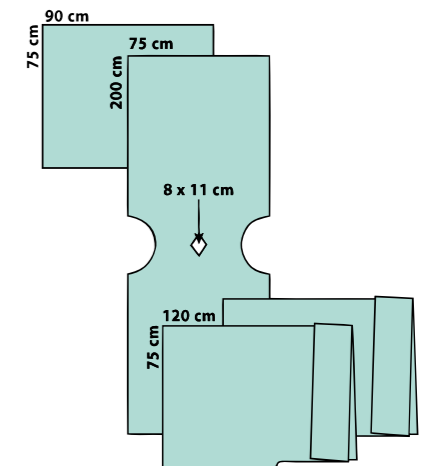

Gynaecology/Urology

TUR Drape **518841**

Dispenser, PU: 60 drapes

Description	Size/cm	Qty./disp.
TUR drape, 2-ply, \diamond 8 x 11 cm non-adhesive aperture, decentral; with sieve	100 x 230	15

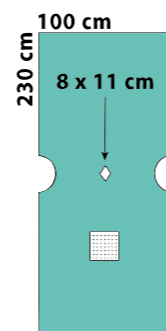

Under Buttocks Drape **508887**

Dispenser, PU: 120 drapes

Description	Size/cm	Qty./disp.
Under buttocks drape, 2-ply with 20 cm turn-up	75 x 100	30

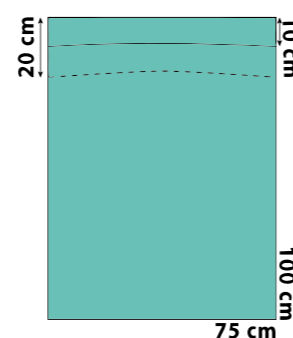

Under Buttocks Drape **506667**

Dispenser, PU: 60 drapes

Description	Size/cm	Qty./disp.
Under buttocks drape, Colordrape, with 20 cm turn-up, 54 x 43 cm non-woven reinforcement and fluid collection pouch with scale, sieve and drainage port	100 x 120	15

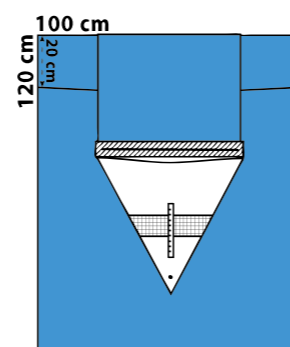

Leggings **888812**

Dispenser, PU: 48 pairs

Description	Length/cm	Qty./disp.
aquamarine 2-ply	75 x 120	12 pairs

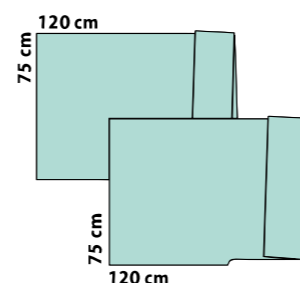

Universal Drapes

	Size/cm	Qty. dispenser or inliner/PU	Ref. no.
Aperture drapes, aperture \varnothing 6 cm	75 x 90	45/270	518822
Aperture drapes, aperture \varnothing 6 cm	45 x 75	70/420	518821
Aperture drapes, adhesive, aperture 6 x 8 cm	75 x 90	40/240	558972
Aperture drapes, adhesive, aperture 7 x 10 cm	100 x 150	25/100	558974
Aperture drapes, adhesive, aperture 16 x 12 cm	200 x 280	200/280	558809
Aperture drapes, variable	75 x 90	30/180	558948
Plain drape	45 x 75	60/360	508825
Plain drape	75 x 95	40/240	508824
OR tape	10 x 50	130/780	591050
Mayo stand cover standard	80 x 145	20/80	547714

Supplementary Products



For holistic comprehensive supplies of the operating theatre, Sengewald offers a multitude of application-friendly supplementary products. Various collection pouches for direct fluid control, diathermy bags, OR tape and velcro fasteners as well as sleeve protectors, leggings and foot covers are available in various materials and measurements.

Camera covers and image intensifier packs, as well as equipment covers in diverse sizes guarantee maximum hygiene safety in the OR.



Fluid Collection/Diathermy Pouches

Fluid Collection Pouches

Description	Size/cm	Qty.	Ref. no.
For shoulders, with 46 cm adhesive U-slit and 2 drainage ports PU: 50 pouches	60/82 x 76	25	589978
Universal, with sieve and drainage port PU: 50 pouches	55 x 50/44	25	589901

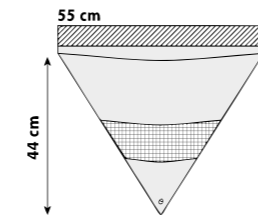
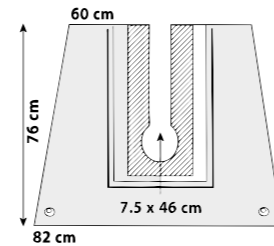

Diathermy Pouches, adhesive, transparent
Dispenser

Description	Size/cm	Qty.	Ref. no.
Single chamber, with bottom fold 5 cm PU: 6 dispenser	33 x 22.5	52	583324
Single chamber, with turn-up PU: 6 dispenser	33 x 28	60	583330
Single chamber, with turn-up PU: 6 dispenser	40 x 28	90	584028
Dual chamber, 27 + 14 cm PU: 6 dispenser	44 x 27	60	584427
MIS single chamber PU: 6 dispenser	50 x 30	45	583850
MIS triple chamber, with turn-up PU: 6 dispenser	24 x 38.5	50	582246
Single chamber, hip PU: 4 dispenser	100 x 68	25	588010

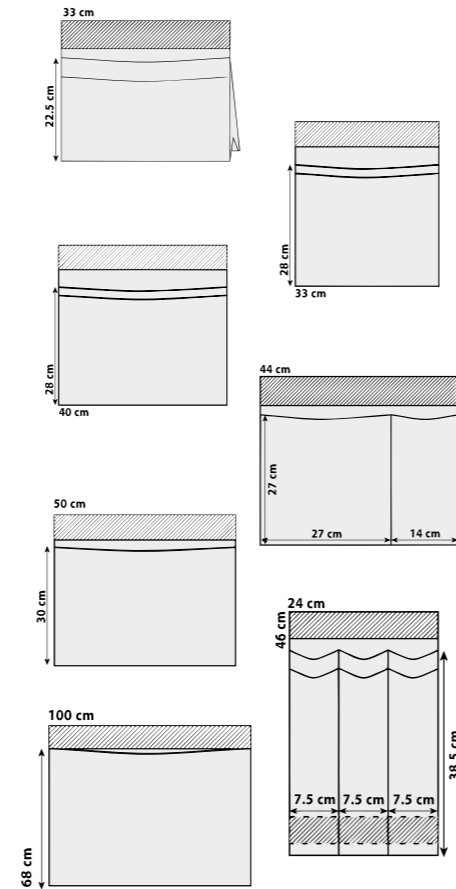

Velcro Strip/OR Tapes/Incision Film

Velcro Strip dispenser

Description	Size/cm	Qty.	Ref. no.
OP velcro strip PU: 6 dispenser	2/2.5 x 24	100	592525

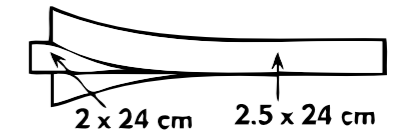

OR Tapes dispenser

Description	Size/cm	Qty.	Ref. no.
Non-woven, standard PU: 6 dispenser	10 x 50	130	591050
Non-woven, elastic PU: 6 dispenser	10 x 50	125	591151
Film PU: 6 dispenser	11 x 50	110	591150
Non-woven, standard PU: 6 dispenser	20 x 25	70	592025
Non-woven, standard PU: 6 dispenser	10 x 25	50 pairs	591025
Non-woven, elastic PU: 6 dispenser	10 x 50	75 pairs	591152
Non-woven, elastic à 5 pcs. PU: 6 dispenser	10 x 50	25 x 5 pouches	591055

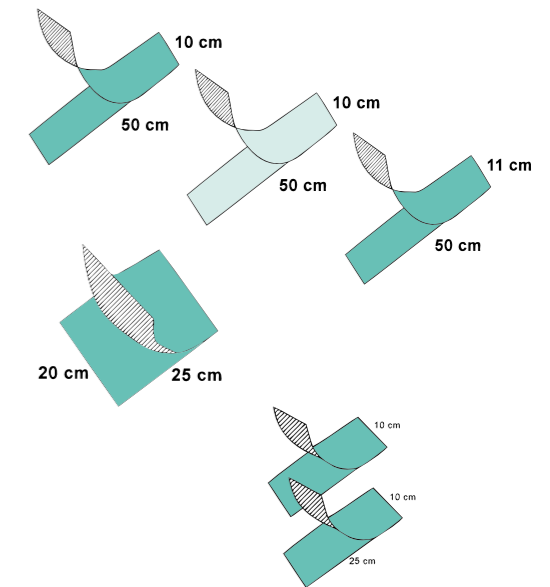

Incision Film dispenser

Description	Size/cm	Qty.	Ref. no.
For ophthalmology PU: 6 dispenser	10 x 18	150	591018

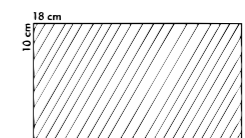

Foot Covers/Stockinettes/Leggings

Foot Covers dispenser

Description	Size/cm	Qty./disp.	Ref. no.
Foot covers, 2-ply PU: 180 pairs	23-32 x 42	30	589950
Foot covers, transparent PU: 300 pairs	25-34 x 45	50	589951

Stockinettes dispenser

Description	Size/cm	Qty./disp.	Ref. no.
Mediwell super + 2 film tape strips PU: 160 stockinettes	33 x 73	40	583355
Mediwell super + 2 film tape strips PU: 100 stockinettes	35 x 120	25	583311
Mediwell super + elastic tape strip PU: 240 stockinettes	17 x 75	60	588827
US model PU: 150 stockinettes	23 x 80	25	580001
US model PU: 90 stockinettes	23 x 110	15	580002
US model PU: 68 stockinettes	32 x 120	17	580003

GYN/URO Leggings dispenser

Description	Size/cm	Qty./disp.	Ref. no.
Mediwell super, 2-ply, film inside PU: 60 pairs	50 x 110	10	588811
Mediwell super, 2-ply, film inside PU: 48 pairs	75 x 120	12	588812
aquamarine, 2-ply, film inside PU: 30 pairs	75 x 120	10	888812

Sleeve Protectors, Mediwell super

Dispenser

Description	Size/cm	Qty./disp.	Ref. no.
2-ply, with cuffs PU: 210 pcs.	22.5 x 57	35	582052

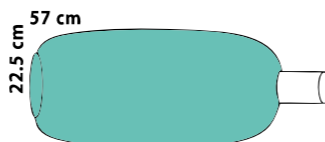
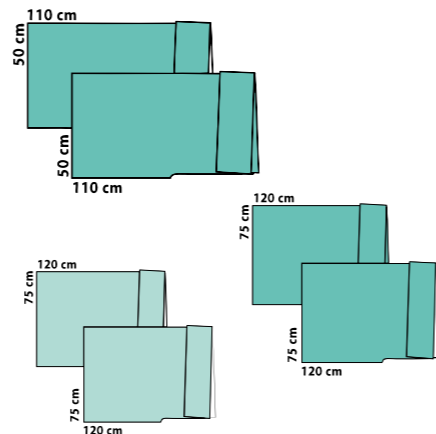
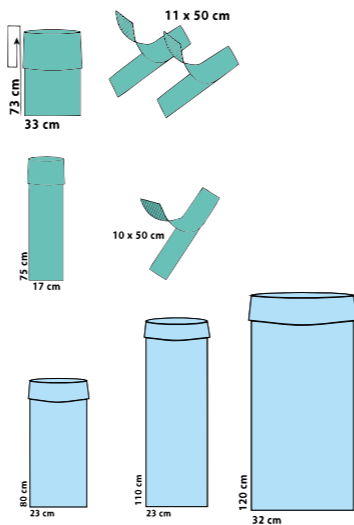
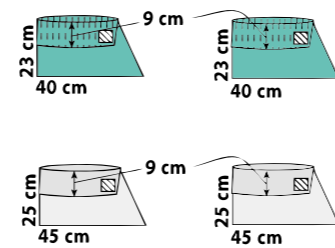

Camera-/Image Intensifier Covers

Camera Tube Covers dispenser

Description	Size/cm	Qty./disp.	Ref. no.
Camera tube cover, reverse PU: 210 covers	13 x 250	35	581322
Camera tube cover, telescopically PU: 192 covers	13 x 250	32	581323
Camera tube cover, telescopically PU: 192 covers	13 x 250	32	581324
Camera tube cover, telescopically PU: 150 covers	13 x 250	25	581325
Camera tube cover, telescopically PU: 120 covers	18 x 250	30	581825

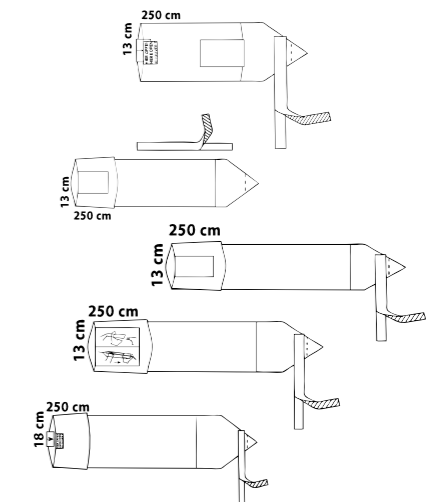

Image Intensifier Covers and Packs dispenser

Description	Qty./disp.	Ref. no.
Pack 1, for Philips equipment, 3-part PU: 72 packs	18	565803
Pack 2, for Siemens equipment, 1-part with 2 OR tapes PU: 40 packs	10	565804
Pack 3, for Philips BV29 equipment, 3-part PU: 24 packs	12	565805
Pack 4, for Siemens ISO-C equipment, 1-part with 2 OR tapes PU: 50 packs	50	565851
Pack 6, for Siemens equipment, 1-part with 3 OR tapes PU: 40 packs	10	565856

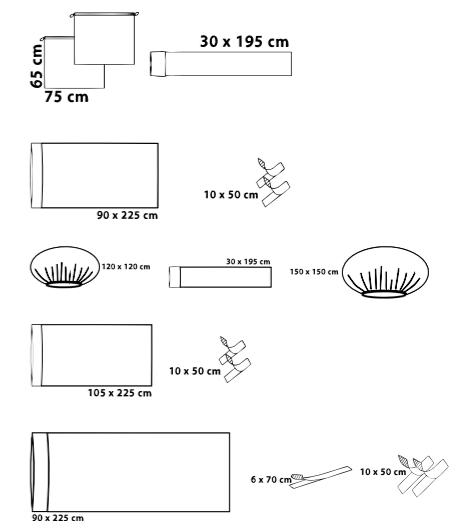

Image Intensifier Cover dispenser

Description	Size/cm	Qty./disp.	Ref. no.
Film pouch with drawstring PU: 140 covers	75 x 65	35	587565

Equipment Covers

Stool Covers dispenser

Description	Size/cm	Qty./disp.	Ref. no.
Mediwell super, 2-ply PU: 90 covers	75 x 75	15	588875
Mediwell super, 2-ply elastified PU: 210 covers	60 x 60	35	588860

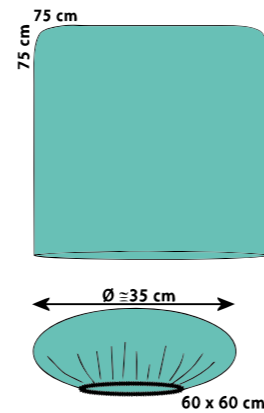

Armrest Covers, Mediwell super, 2-ply

Dispenser

Description	Size/cm	Qty./disp.	Ref. no.
with integral tape strip PU: 90 pairs	37.5 x 73	15 pairs	583573
elastified PU: 80 pairs	25 x 70	20 pairs	583574

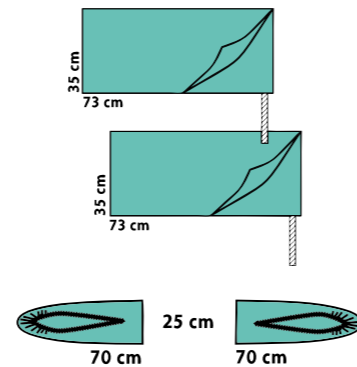

X-Ray Cassette Cover, Mediwell

Dispenser

Description	Size/cm	Qty./disp.	Ref. no.
3-ply, adhesive, overall length 58 cm PU: 240 covers	50 x 50	40	585050

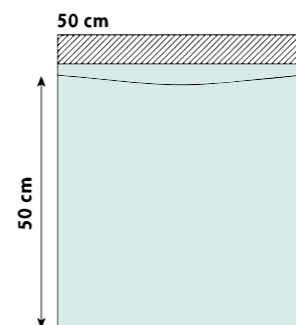

Equipment Covers, transparent film

Dispenser

Description	Size/cm	Qty./disp.	Ref. no.
elastified, round PU: 300 pcs.	25 x 25	50	582515
elastified, round Only available as a non-sterile pack component	45 x 45	35	584520-9
elastified, round PU: 180 pcs.	60 x 60	30	586030
elastified, round PU: 150 pcs.	80 x 80	25	588040
elastified, rectangular PU: 240 pcs.	80 x 45	40	588045
elastified, rectangular PU: 150 pcs.	110 x 80	25	581180
elastified, round PU: 120 pcs.	100 x 100	20	581050
elastified, round PU: 72 pcs.	120 x 120	12	581260
elastified, round Only available as a non-sterile pack component	150 x 150		581576-9

Example: equipment cover round

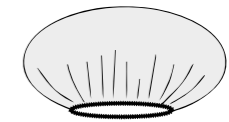

Example: equipment cover rectangular

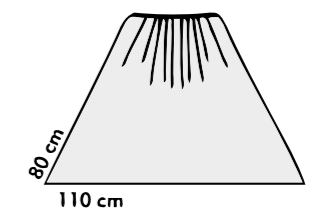
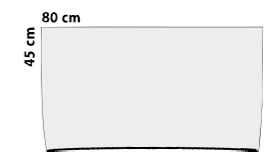

Lead Window Cover, transparent film

Dispenser

Description	Size/cm	Qty./disp.	Ref. no.
with drawstring PU: 100 pcs.	80 x 110	25	588011

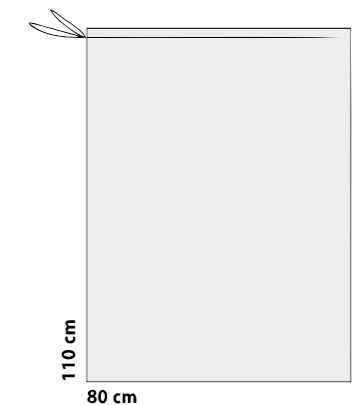

Film Pouch, transparent film

Dispenser

Description	Size/cm	Qty./disp.	Ref. no.
with drawstring PU: 240 pcs.	65 x 60	40	586560

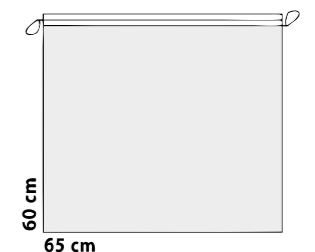

Accessory

Surgical Suture Bag of transparent film

Description	Size/cm	Ref. no.
Film, PE/PA/PE, adhesive, with 3 pouches 67 x 90 mm	19.5 x 22.5	589960-9

Only available as a non-sterile pack component

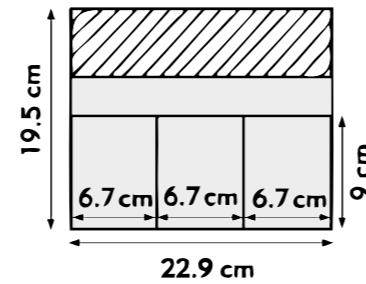

NaCl Bowl Liner

PU: 72 pcs.

Description	Size/cm	Qty./disp.	Ref. no.
PE-film with central bowl Ø 31.5 cm, max. depth 12 cm	130 x 160	18	588855

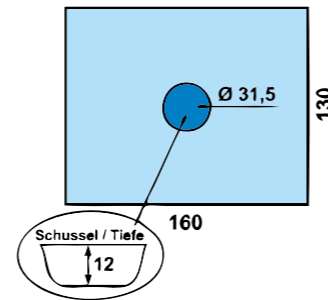

Pillowcase Cover non-sterile

PU: 250 covers

Description	Size/cm	Qty.	Ref. no.
Pillowcase, Mediwell super, 2-ply	40 x 50	50	588851-9

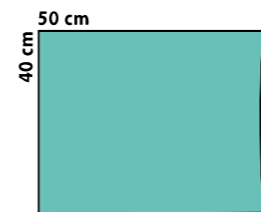

OR Plain Drapes, rolled

Description	Size/cm	Qty.	Ref. no.
Plain drape, rolled PU: 50 pcs.	7 x 16	50	588880
Plain drape, rolled PU: 9 pcs.	16 x 30	9	588881
Plain drape, rolled PU: 3 pcs.	60 x 60	3	588882

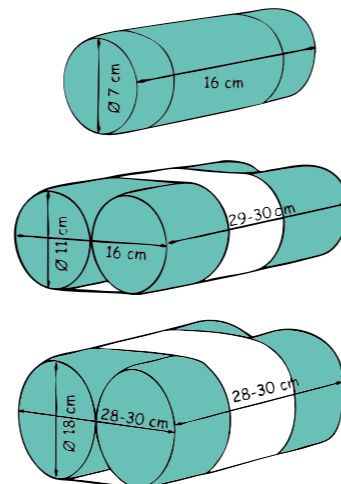

Perineal Drape Mediwell super, 2-ply

Dispenser, PU: 300 pcs.

Description	Size/cm	Qty./disp.	Ref. no.
Adhesive with elasticated side	50/22 x 53	50	585053

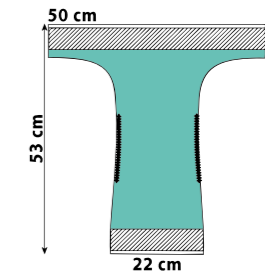

Elastic Inlets non-sterile

Description	Size/cm	Qty.	Ref. no.
Aperture Ø 7 cm, central PU: 1,000 pcs.	25 x 40	100	582540-9
Aperture Ø 7 cm, central PU: 500 pcs.	40 x 40	50	584040-9

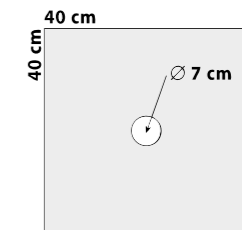

OR Gowns



Our OR gowns ensure safety for personnel and patients: Mediwell soft is comfortable to wear due to its textile-like structure and the lightweight Mediwell light quality offers optimal patient comfort.

Thanks to the wide range including products in various materials and sizes the suitable gown for every intervention can be selected. All OR gowns are free of latex and PVC.



OR Gowns Standard/Reinforced

Gowns made of Mediwell soft spunlace non-woven, breathable, textile-like structure, fluid-repellent; each gown is supplied with **two 30 x 40 cm hand towels and overwrap**

Standard Gowns/SP
without reinforcement

Description	Length/cm	Qty.	Ref. no.
Only available as a non-sterile pack component	M=120		464411-9
PU: 24 gowns	L=130	12	464413
PU: 24 gowns	XL=150	12	464416
PU: 24 gowns	XXL=170	12	464419
PU: 24 gowns, extra wide (hem 190 cm)	XL=150	12	464458

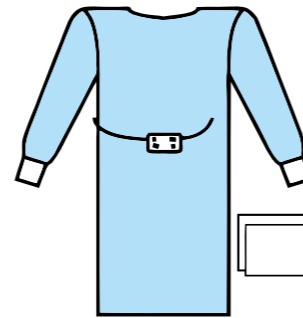

Special Gowns/HP
with bacteria and fluidproof interior reinforcement made of PE film

Description	Length/cm	Qty.	Ref. no.
Breathable sleeve reinforcement PU: 24 gowns	L=130	12	464414
Breathable sleeve reinforcement PU: 24 gowns	XL=150	12	464417
Breathable sleeve reinforcement PU: 18 gowns	XXL=170	9	464430

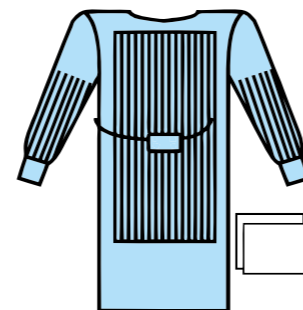

Special Gowns/HP
with bacteria and fluidproof exterior reinforcement made of PE film

PU: 24 gowns

Description	Length/cm	Qty.	Ref. no.
Breathable interior sleeve reinforcement	XL=150	12	464415
Breathable interior sleeve reinforcement	XXL=170	12	464418

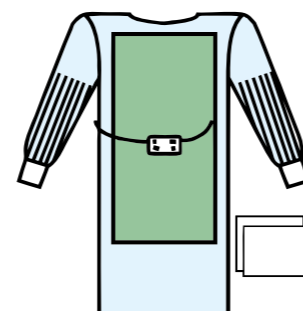

OR Gown Pack, reinforced **563810**

PU: 6 packs

Description	Size or length/cm	Qty.	Ref. no.
Medinop overwrap	85 x 100	1	628510
OR gowns, spunlace, non-reinforced	L = 130	1	464413
OR gowns, spunlace, reinforced	XL = 150	4	464417
OR gowns, spunlace, reinforced	XXL = 170	1	464430

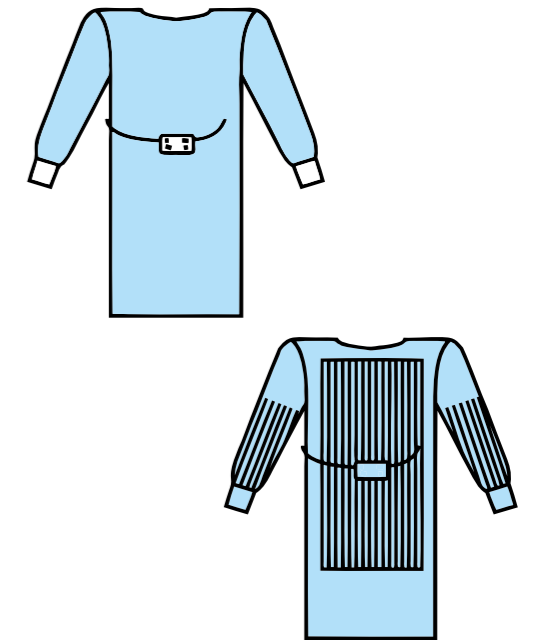

HP: fulfils the requirements of EN 13795 for High Performance
SP: fulfils the requirements of EN 13795 for Standard Performance

OR Gowns Standard/Reinforced

Gowns made of Mediwell soft spunlace non-woven, breathable, textile-like structure, fluid-repellent; each gown is supplied with **two 30 x 40 cm hand towels**

Special Tie Gowns/SP

Description	Length/cm	Ref. no.
	L=130	464423-9
	L/XL=140	464462-9
	XL=150	464426-9

Only available as a non-sterile pack component

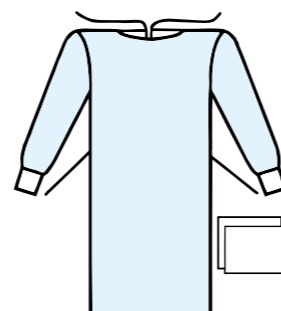

Gowns made of Mediwell light SMMMS non-woven 47g/m², breathable, highly comfortable to wear, fluid-repellent; each gown is supplied with **two 30 x 40 cm hand towels**

Standard Gowns/SP

Description	Length/cm	Qty.	Ref. no.
non-reinforced PU: 28 gowns	L=135	14	464472
non-reinforced PU: 26 gowns	XL=150	13	464473
SMMMS reinforced PU: 26 gowns	XL=150	13	464475

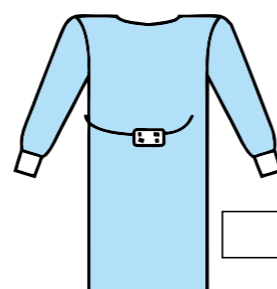

TUR Gown

PU: 30 gowns

Description	Length/cm	Qty.	Ref. no.
Non-woven yoke section	L/XL=140	15	464455
Non-woven yoke section	XL=150	15	464428



Sleeve Protectors, Mediwell super

PU: 210 pcs.

Description	Size/cm	Qty./disp.	Ref. no.
2-ply, with cuff	22.5 x 57	35	582052

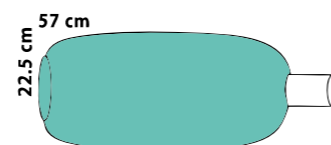

HP: fulfill the requirements of EN 13795 for High Performance
SP: fulfill the requirements of EN 13795 for Standard Performance

Gowns made of Mediwell light SMMMS non-woven, breathable, textile-like structure, fluid-repellent; each gown is supplied with **two 30 x 40 cm hand towels**

Standard Gowns/SP

Non-reinforced

Description	Length/cm	Qty.	Ref. no.
PU: 34 gowns	M=120	17	464431
PU: 30 gowns	L=130	15	464433
PU: 28 gowns	XL=150	14	464436
PU: 26 gowns	XXL=170	13	464491

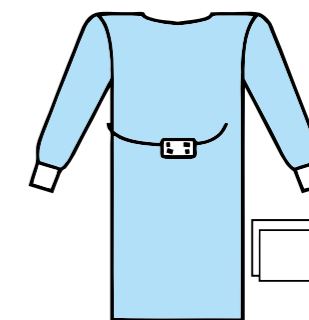

Special Gowns/SP

with interior SMMMS reinforcement

Description	Length/cm	Qty.	Ref. no.
PU: 30 gowns	L=130	15	464434
PU: 28 gowns	XL=150	14	464437
PU: 28 gowns	XXL=170	14	464492

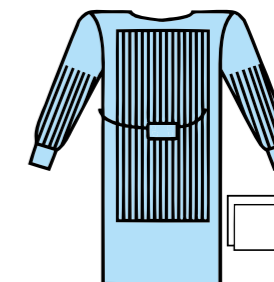

Special Gowns/HP

with bacteria and fluidproof interior reinforcement made of PE film

Description	Length/cm	Qty.	Ref. no.
PU: 24 gowns	XL=150	12	464438
PU: 22 gowns	XXL=170	11	464439

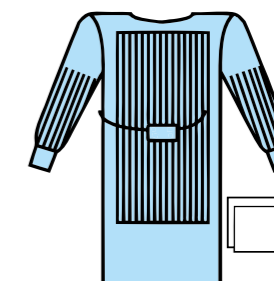

Gown Pack standard

563840

PU:14 packs

Description	Size or Length/cm	Qty.	Ref. no.
Medinop overwrap	85 x 100	1	628510
OR Gown, SMS, non-reinforced	XL = 150	3	464436

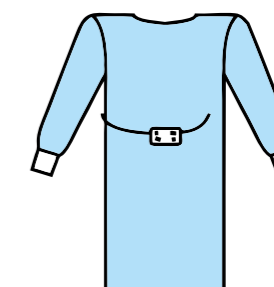

HP: fulfill the requirements of EN 13795 for High Performance
SP: fulfill the requirements of EN 13795 for Standard Performance

Protection Products



Protection covers and sheets, as well as aprons supplement our product portfolio and fulfil the requirements of the highest hygiene safety. In addition to standard articles, we provide complete and individual solutions tailored to the specific needs of our customers.

Our scrubs clothing contributes towards the protection of patients, personnel and visitors.



Scrub Suits/Non-Woven Jackets (Unsterile)

Scrub Suits, Mediwell soft and Mediwell 43 (SMS) tunics with press stud and 3-pocket trousers with tie waists and 2 back pockets

PU: 4 x 25 pcs.

Description	Size/cm	SMS 43 Ref. no.	Soft Ref. no.
Size S, tunic	52 x 70	469940	469930
Size S, trousers	40 x 96	469941	469931
Size M, tunic	57 x 72	469942	469932
Size M, trousers	48 x 106	469943	469933
Size L, tunic	63 x 72	469944	469934
Size L, trousers	54 x 112	469945	469935
Size XL, tunic	67 x 75	469946	469936
Size XL, trousers	60 x 120	469947	469937
Size XXL, tunic	70 x 76	469948	469938
Size XXL, trousers	66 x 125	469949	469939

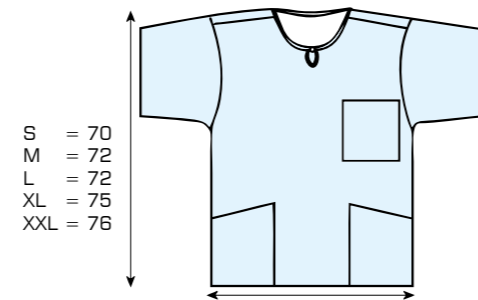

S = 70
M = 72
L = 72
XL = 75
XXL = 76

S = 52
M = 57
L = 63
XL = 67
XXL = 70

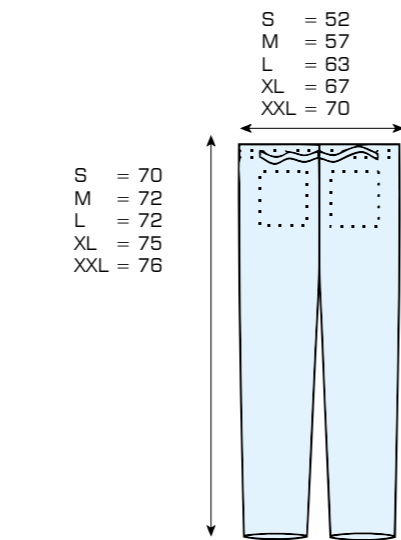

S = 70
M = 72
L = 72
XL = 75
XXL = 76

S = 52
M = 57
L = 63
XL = 67
XXL = 70

Non-Woven Jackets

Mediwell soft with press studs and 2 pockets

PU: 50 pcs.

Description	Length/cm	Qty.	Ref. no.
Size M	72	1	469950
Size L	74	1	469951
Size XL	76	1	469952

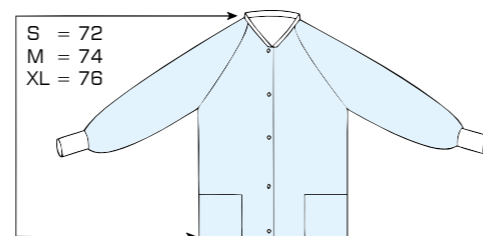

S = 72
M = 74
XL = 76

Protection/Visitor Gown

Protection Gown 464468

PP spunbond

PU: 100

Description	Length/cm
Colour: light blue, with tie belt, OR gown folding, knitted cuffs	125

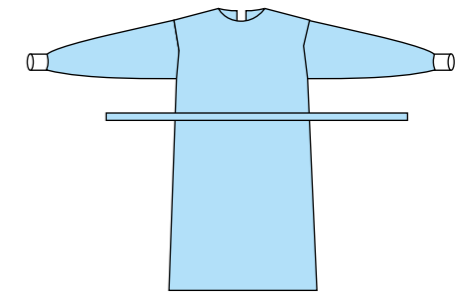

Protection Gown 465521

SPP non-woven fabric with PE lamination on front and arms

PU: 100

Description	Length/cm
Colour: yellow, velcro at the neck and tie around the waist, knitted cuffs	140

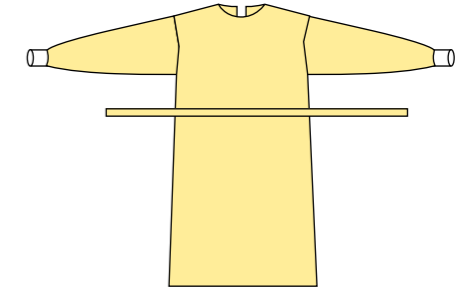

Visitor Gown 465522

SPP non-woven fabric

PU: 100

Description	Length/cm
Colour: purple, velcro at the neck and tie around the waist, knitted cuffs	130

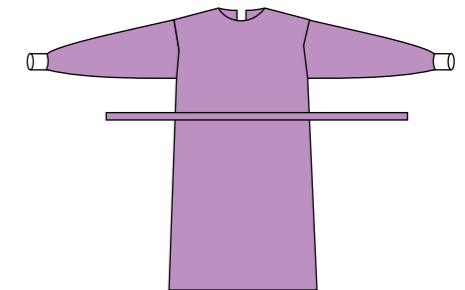

Visitor Gown 465523

SPP non-woven fabric

PU: 100

Description	Length/cm
Colour: light green, velcro at the neck and tie around the waist, elastic cuffs	115

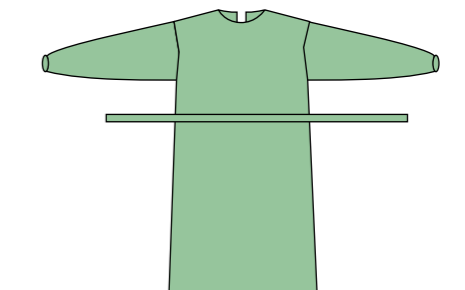

Disposable Socks

Disposable socks
cotton and polyester

466001

PU: 160

Description	Size/cm
Colour: white, packed by pair in dispenser (40 pairs)	40 x 8.5

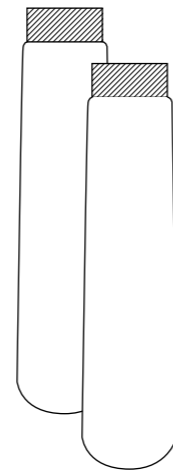

Protection Sheets/Aprons/Examination Couch Covers

Medinop

Protective sheets	Qty. disp. or inliner/PU	Format/cm	Ref. no.
Protective sheets	700	37.5 x 40	623840
Protective sheets	700	45 x 75	624575
Protective sheets	500	60 x 75	626075
Protective sheets	400	75 x 90	627590
Protective sheets	200	75 x 140	627814
Protective sheets	150	75 x 175	627818
Protective sheets	150	75 x 200	627820
Protective sheets	125	75 x 210	627821
Protective sheets	150	85 x 175	628518
Protective sheets	100	85 x 210	628521

Examination couch covers	Qty./PU	Format/cm x m	Ref. no.
2-ply, white, on rolls, perforated every 28 cm	10	39 cm x 50 m	773950
2-ply, white, on rolls, perforated every 28 cm	10	44 cm x 50 m	774450
2-ply, white, on rolls, perforated every 28 cm	10	50 cm x 50 m	775050
2-ply, white, on rolls, perforated every 28 cm	10	55 cm x 50 m	775550
2-ply, white, on rolls, perforated every 28 cm	10	59 cm x 50 m	775950
2-ply, white, on rolls, perforated every 28 cm	8	74 cm x 50 m	777450

Aprons	Qty. disp. or inliner/PU	Format/cm	Ref. no.
White PE film, in dispensers	75 / 600	75 x 110	407511
White PE film, in dispensers	75 / 600	75 x 130	407513
White PE film, in dispensers	75 / 450	75 x 150	407515
White PE film, in dispensers	75 / 450	75 x 170	407517
Mediwell, 2-ply, in bundles à 50 pcs.	400	75 x 110	417511
Mediwell, 2-ply, in bundles à 50 pcs.	300	75 x 130	417513
Mediwell, 2-ply, in bundles à 50 pcs.	300	75 x 150	417515
Mediwell, 2-ply, in bundles à 50 pcs.	250	75 x 170	417517

Medinop is a 2-ply material made of 100% virgin, oxygen-bleached, white tissue and transparent PE film. It is soft, very drapeable, absorbent, impermeable to fluids and bacteria, rub-resistant and extremely suitable for use as a pack overwrap with a secondary application as a sterile field or bottom/protective sheet.

This catalogue only contains products of our **Secu-Drape®** Brand

Single sterile with indication of the packaging unit:

Article deliverable from stock

Lead time: usually kept in stock

Minimum order quantity: 1 packaging unit (PU)

All drapes or gowns are available as a pack component.

Pack component (article number ends with "-9"):

These products are only available as non-sterile pack component.

If articles are required as single sterile products, it's available on request.

Lead time: upon request

Product	Page(s)	Product	Page(s)	Product	Page(s)	Product	Page(s)
4 Femoral Radial Angiography Drape	37	Examination Couch Covers	113	NaCl Bowl Liner	100	Split Aperture Drape	20, 61
Adhesive Drapes	16, 17, 80	Extremity Drapes	41, 81, 88	Neurosurgery Drapes	72	Sterioplast	113
Adhesive Drapes with special adhesive for sensitive skin	18	Extremity Drapes "small"	48, 88	Non-Woven Jackets	110	Stool Covers	53, 77, 98
Angiography Drapes	36-37	Extremity Packs	42	OR Gown Pack, reinforced	105	Strumectomy Pack	28
Aperture Drapes	14, 76	Eye Drape	75-76	OR Gown Pack, standard	104, 106, 107	Surgical Suture Bag	100
Aperture Drapes, adhesive	14, 76	Film Pouch	99	OR Gown reinforced	104, 106, 107	Tie Gowns	106
Aprons	113	Fluid Collection Pouch	51	OR Gown standard	104	TUR Gown Drape with leggings and sieve	56
Armrest covers	77, 98	Fluid Collection Pouches	61, 94	OR Plain Drapes, rolled	100	TUR Gown Drape "small" with leggings and sieve	56
Arthroscopy Drapes	43, 87	Fluid Collection Pouches for Arthroscopies	51	OR Tape	53, 74, 95	TUR Gown Drape with leggings and fluid collection pouch	56
Arthroscopy Drapes "small"	43	Foot Covers	35, 96	Pacemaker Drape	35	TUR Gown Drape "small" with leggings and fluid collection pouch	56
Arthroscopy Pack	44-45, 86-87	GYN Drapes	64	Paediatric Drapes	80	TUR Gown Packs	58, 89
Arthroscopy Pack with fluid collection pouch	44	GYN Pack, standard	64	Paediatric Aperture Drapes	80	Turban Drape	74
Baby Drape	67	GYN/LAP Drape	68	Paediatric Packs	80-81	Under Buttocks Drape	68, 69, 90
Back Table Cover	21	GYN/LAP Drape T-Form	68	Paediatric/ENT Split Sheet	74	Universal Pack super	24
Bypass Pack	33	GYN/URO Leggings	96	Perineal Drape	101	Universal Pack, paediatrics	24, 80
Camera Tube Covers	51, 97	GYN-TVT Drape with leggings	57, 64	Pfannenstiel Drape	65	Universal Pack, standard	24, 84
Cardio/Angiography Drapes		Hand Surgery Drapes	47, 87	Pfannenstiel Pack, standard	65	Universal Pack, super+	25
Cardio/Thoracic Drape	32	Hand/Foot Drapes	48, 88	Pillowcase Cover	100	Universal Packs	24-25
Cardiovascular/Bypass Pack	33	Hand/Foot Pack	48, 88	Plain Drapes	12-13	Universal Urology Drape	57
C-Section Drape	66, 67	Hip Drape T-Form	49	Protection Gowns	111	Urology Drapes	59
C-Section Drape T-Form	66, 67	Hip Pack standard	49	Protective Sheets	113	Urology Packs	58
C-Section Pack, standard	66	Hybrid Drape	34	Rectal Shield	61	U-slit Sheets Packs	28
CYST Drape	60, 68	Image Intensifier Cover	52	Rectum Drape T-Form	27	Variable Aperture Drapes	14
CYST Pack	60, 69, 89	Image Intensifier Covers and Packs	52, 97	Rectum Drape with leggings	27	Varicose Vein Drape	35
DaVinci Drape, T-Form	59	Incision Film	95	Scrub Suits, non-sterile	110	Velcro Strip	51, 95
Diathermy Bag	94	Laminectomy Drape	73	Shoulder Drape "Beach Chair"	46	Vertical Isolation Drape	50
Disposable Socks	112	Laminectomy Drape T-Form	73	Sleeve Protectors	96, 106	Vertical Isolation Drape Packs	50
Dual Extremity Drape	48	Lead Window Cover	99	Split Sheet Packs	29, 85	Visitor Gown	111
Ear Drape	74	Leggings	61, 69, 90	Split Sheet with film side strips	20	X-Ray Cassette Cover	98
Elastic Inlets, non-steril	52, 101	Mayo Stand Cover	21	Split Sheet with leggings	59		
ENT Drapes	74	MIS Drape	26	Split Sheet with rectal fenestration and leggings	59		
Epidural Drapes	15, 16	MIS Drape T-Form	26	Split Sheet, bilateral	19		
Equipment Covers	99	MIS Drape with leggings	26	Split Sheet, paediatric	81		
		MIS Pack	26	Split Sheets	19-20, 40		

Sengewald Klinikprodukte GmbH
Adlerstraße 2
83101 Rohrdorf-Thansau
Germany

FON +49 (0)8031 7224-0
FAX +49 (0)8031 7224-297
sengewald@stsmedicalgroup.com
www.sengewald.de

